

# SPECIFICATION FOR APPROVAL

REF. :

PROD. NAME	Multilayer Power Inductor	ABC'S DWG NO.		MP2016□□□□P□-□□□	
		REV.	20240126-B	PAGE	1

**I . Configuration and dimensions :**

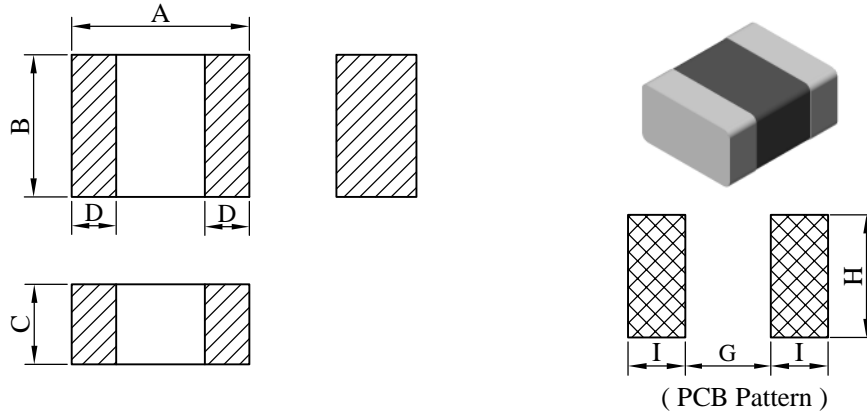

Unit : mm

A	B	C	D	G	H	I
2.00 ±0.2	1.60 ±0.2	1.0 max.	0.50 ±0.3	1.00	1.75	1.05

**II . Materials :**

- a . Body : Ferrite
- b . Internal conductor : Silver
- c . Terminal electrode : Ag / Ni / Sn
- d . Product weight : 15.0 mg (ref.)
- e . Products comply with RoHS' requirements
- f . Halogen free

**III . General specification :**

- a . Operating temp. : -55°C ---- +105°C
- b . Terminal strength :

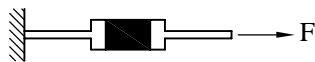

Type	F ( kgf )	Time ( sec )
MP2016	0.8	30±5

- c . Resistance to soldering heat :  
Solder temp. : 260°C  
Dip time :10 sec max.

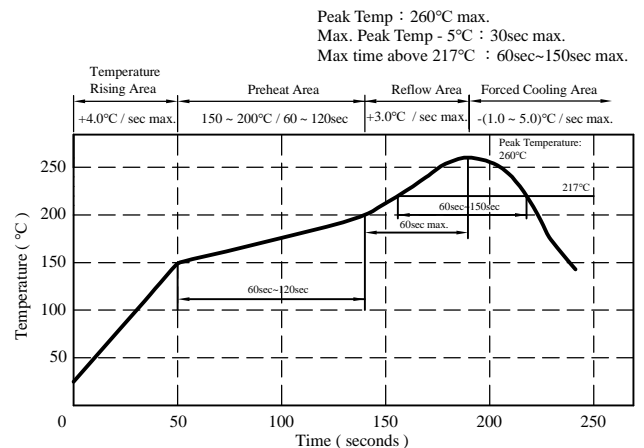

AR-001C

# SPECIFICATION FOR APPROVAL

REF. :

PROD. NAME	Multilayer Power Inductor	ABC'S DWG NO.	MP2016□□□□P□-□□□		
		REV.	20240126-B	PAGE	2

#### IV . Electrical characteristics :

DWG. No.	Inductance ( $\mu$ H)	SRF ( MHz ) min.	RDC ( $\Omega$ )		Rated Current ( mA ) max.
			max.	typ.	
MP20161R0MP□-□□□	1.00 $\pm$ 20%	70	0.12	0.09	1300
MP20161R5MP□-□□□	1.50 $\pm$ 20%	40	0.13	0.10	1200
MP20162R2MP□-□□□	2.20 $\pm$ 20%	50	0.14	0.11	1200
MP20163R3MP□-□□□	3.30 $\pm$ 20%	40	0.16	0.13	1100
MP20164R7MP□-□□□	4.70 $\pm$ 20%	20	0.20	0.16	900

- 1). Inductance Test Condition. :1MHz / 60mV
- 2). Electrical specifications at 25°C
- 3). Rated Current : Base on temp. rise 40°C max.

AR-001C

# SPECIFICATION FOR APPROVAL

REF. :

PROD. NAME	Multilayer Power Inductor	ABC'S DWG NO.	MP2016□□□□P□-□□□		
		REV.	20240126-B	PAGE	3

V . Curve :

MP20161R0MP□

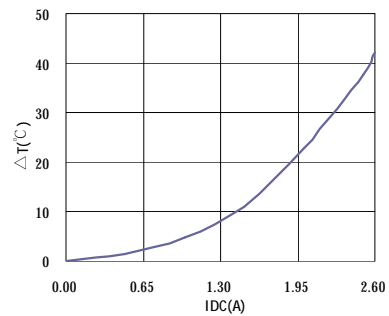
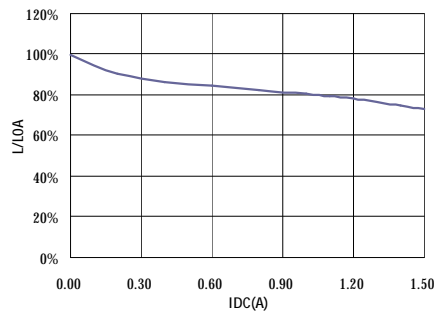

MP20162R2MP□

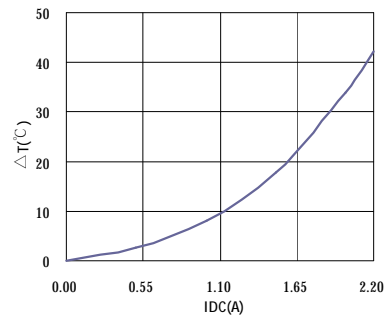
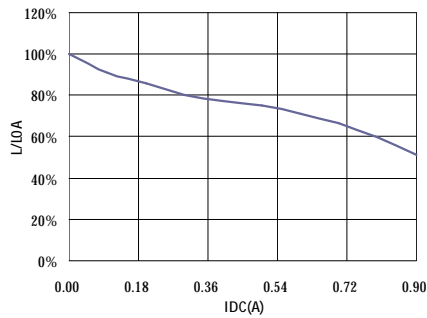

MP20163R3MP□

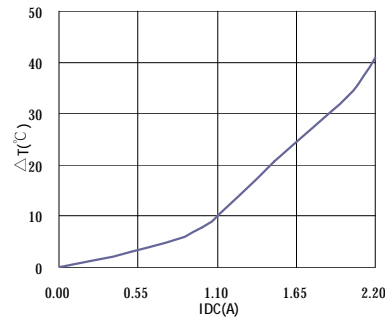
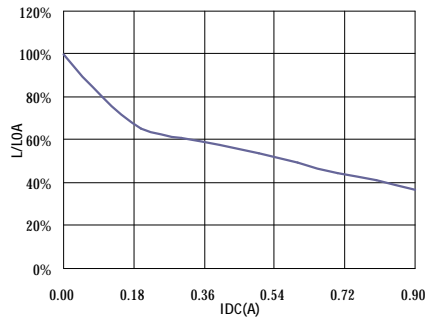

MP20164R7MP□

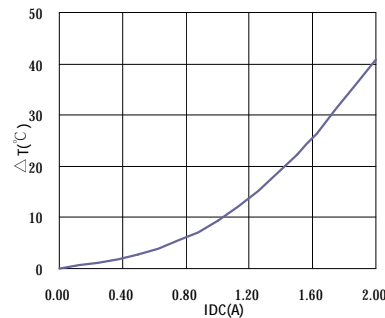
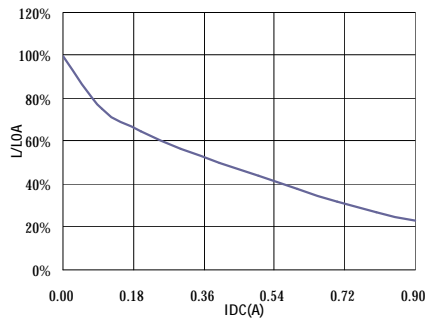

AR-001C

# SPECIFICATION FOR APPROVAL

REF. :

PROD. NAME	Multilayer Power Inductor	ABC'S DWG NO.		MP2016□□□□P□-□□□	
		REV.	20240126-B	PAGE	4

## VI . Packaging information :

### (1) Confihuration

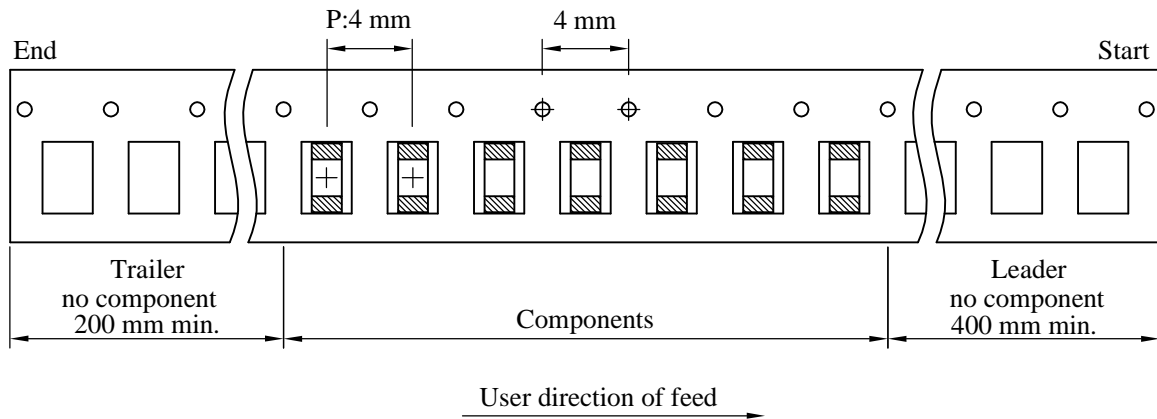
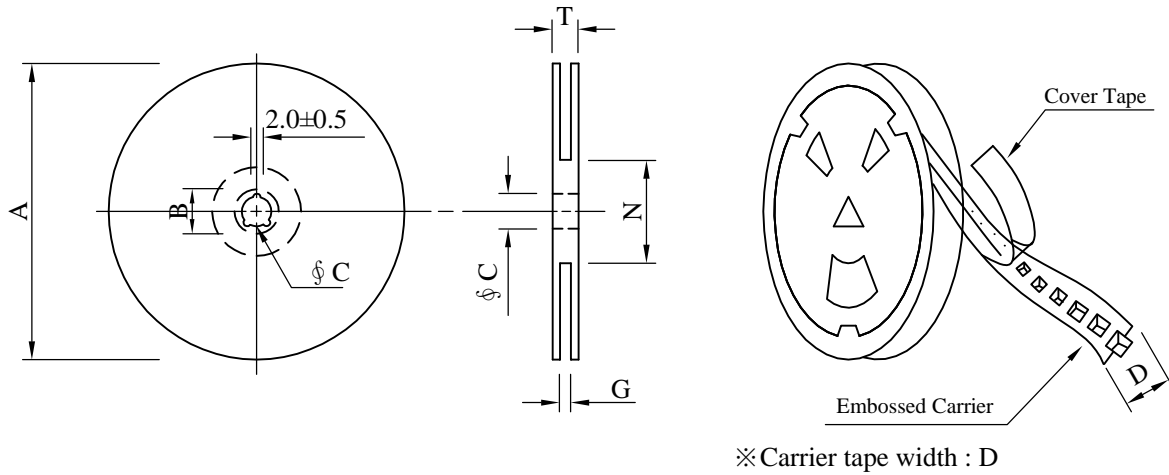

### (2) Dimensions

Unit:mm

Style	A	B	C	D	G	N	T
07 - 08	178	21±0.8	13	8	10 <sup>+0</sup>	50 <sup>-0</sup>	12.5

### (3) Q'TY & G.W. Per package

Code	Inner : Reel			Outer : Carton		
	Q'TY (pcs)	G.W. (g)	Style	Q'TY(pcs)	G.W. (Kg)	Size (cm)
B	3,000	120	07 - 08	150,000	6.6	41 x 39 x 22

AR-001C

# SPECIFICATION FOR APPROVAL

REF. :

PROD. NAME	Multilayer Power Inductor	ABC'S DWG NO.	MP2016□□□□P□-□□□		
		REV.	20240126-B	PAGE	5

VII . Drawing number expression :

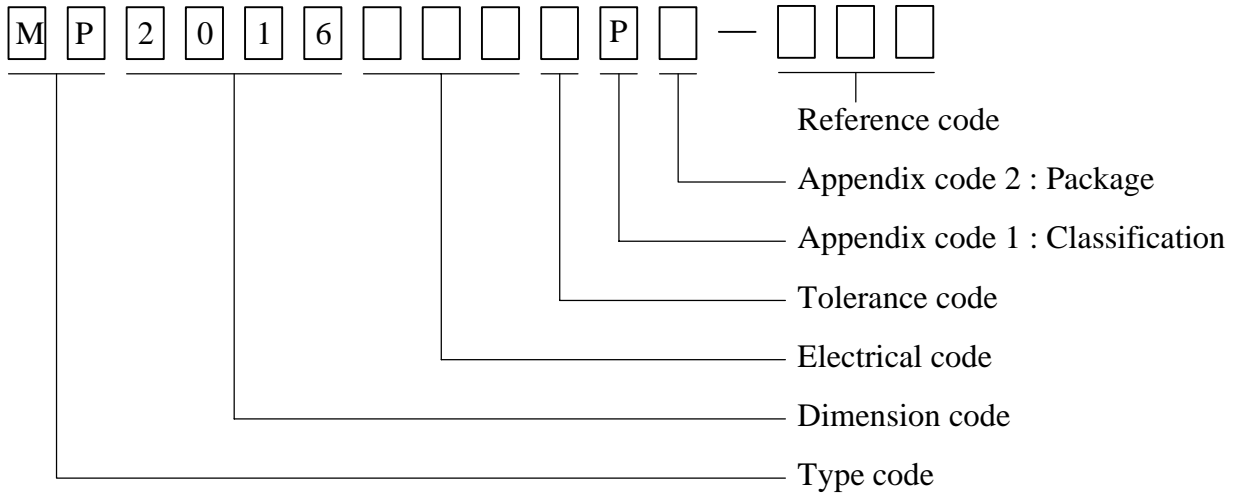

Appendix code 1 : Product Classification

Appendix code 2 : Package Information

Code	Inner package	Cover tape	Carrier tape	Bag	Package Q'TY	Remark
B	T/R (Reel package)	Heat seal	Non-antistatic	Non-antistatic	3,000 pcs	

AR-001C

# SPECIFICATION FOR APPROVAL

REF. :

PROD. NAME	Multilayer Power Inductor	ABC'S DWG NO.	MP2016□□□□P□-□□□		
		REV.	20240126-B	PAGE	6

## VIII . Reliability test :

Item	Reference documents	Test Condition	Test Specification
1.High Temperature Exposure	MIL-STD-202 Method 108	1.Temperature: 105°C 2.Time:1008 hours. 3.Measurement : After placing for 24 hours min.	1.Body: No damage 2.Inductance shall not change more than ±20%.
2.Low Temperature Exposure	JESD22-A 119	1.Temperature: -40°C 2.Time:500 hours. 3.Measurement : After placing for 24 hours min.	1.Body: No damage 2.Inductance shall not change more than ±20%.
3.Temperature Cycling	JESD22-A 104	1.Temperature: -55°C ~ 105°C 2.Number of cycle:100 cycle 3.Dwell time:30 minutes 4.Measurement : After placing for 24 hours min.	1.Body: No damage 2.Inductance shall not change more than ±20%.
4.Biased Humidity Test	MIL-STD-202 Method 103	1.Temperature:40±5 °C 2.Time:1008 Hours 3.Humidity: 95% RH. 4.Measurement : After placing for 24 hours min.	1.Body: No damage 2.Inductance shall not change more than ±20%.
5.Vibration Test	MIL-STD-202 Method 204	1.Frequency and Amplitued : 10-55-10 Hz, 1.5 mm. 2.Direction:X, Y, Z 3.Test duration:2 hours for each direction, 6 hours in total.	Appearance: No damage
6.Resistance To Soldering Heat Test	MIL-STD-202 Method 210	1.Solder Temp. : 260±3°C 2.Immersion time : 6±1 sec 3.Preheating : 100°C to 150°C, 1 minute. 4.Measurement : After placing for 24 hours min.	1.Appearance: No damage 2.Inductance shall not change more than ±20%.
7.Solderability Test	J-STD-002	1.Preheat : 150°C,60 seconds 2.Solder temperature : 235±5°C 3.Flux 4.Dip time : 4±1 seconds	The terminal shall be at least 90% covered with fresh solder.
8.Terminal Strength Test	IEC 60068-2-21	1.Apply push force to samples mounted on PCB. 2.Force: Refer to product specification. 3.Dwell time : >25 seconds.	The terminal electrode and the body shall not be damaged by the forces applied on the right conditions.
9.Board Flex	JIS-C-6429	1.Deflection speed : 1 mm/ sec 2.Amount of deflection : 1.2 mm 3.Span : 90 mm 4.Direction for test : Bottom of PCB 5.Holding time : 60 seconds.	1.Appearance: No damage 2.The terminal electrode and the body shall not be damaged by the forces applied on the right conditions.

AR-001C

# SPECIFICATION FOR APPROVAL

REF. :

PROD. NAME	Multilayer Power Inductor	ABC'S DWG NO.		MP2016□□□□P□-□□□	
		REV.	20240126-B	PAGE	7

## IX . Safety notes :

1. Products do not be used in related applications that directly affect the personal safety system or cause significant impacts and losses on society. If you apply to these applications, please be sure to contact us at first to confirm.  
產品不可使用於直接影響人身安全系統或對社會會造成重大影響與損失之相關用途，若您應用於此，請務必優先與我們聯繫確認。
2. The storage period is less than 12 months. Ensure to follow the storage conditions (Temperature: 5 to 30°C, Humidity: 10 to 60% RH or less). If the storage time is exceeded the limit, the electrodes might be deteriorate of terminal soldering.  
儲存期不超過12個月，務必遵守儲存條件（溫度：5至30°C，濕度：10至60%RH以下）。如果超過了儲存時間，端子電極可能會氧化而影響焊接。
3. Do not use or store in locations where there are conditions such as gas corrosion (salt, acid, alkali, etc.).  
不要在有氣體腐蝕等條件的地方使用或存放（鹽，酸，鹼等）。
4. Soldering corrections after mounting should be within the range of the conditions determined in the specifications. If overheated, a short circuit, performance deterioration, or lifespan shortening may occur.  
安裝時的焊接條件應在規格範圍內。如果超過要求，可能會發生短路，性能下降或壽命縮短。
5. When using, it should try to avoid excessive mechanical impact on the product, such as collision / drop ... and other reasons.  
使用時，應盡量避免產品受到過度機械衝擊，如碰撞/掉落... 等原因。
6. When embedding a printed circuit board where a chip is mounted to a set, be sure that residual stress is not given to the chip due to the overall distortion of the printed circuit board and partial distortion such as at screw tightening portions.  
將已安裝新片的電路板組裝到裝置時，請注意應盡量避免電路板受到組裝變形... 等，導致產品受到應力。
7. Self heating (temperature increase) occurs when the power is turned ON, so the tolerance should be sufficient for the set thermal design.  
產品會因通電而自我發熱(溫度上升)，因此在熱影響設計方面，需保留適當公差。
8. Do not expose the products to magnets or magnetic fields.  
請勿將產品暴露於磁鐵或是磁場中。
9. If you would like to use this products to performance and/or quality require a more stringent level of safety or reliability, or whose failure, malfunction or trouble could cause serious damage to society, person or property, or if you have special requirements exceeding the range or conditions set forth in the each catalog, please contact us.  
如果您希望將此產品用於性能和/或質量要求更嚴格的安全性或可靠性，或其失敗、故障或麻煩可能對社會、個人或財產造成嚴重損害，或者您有特殊情況要求超出目錄中規定的範圍或條件，請與我們聯繫。

AR-001C