

# SPECIFICATION FOR APPROVAL

REF. :

PROD. NAME	Shielded SMD Power Inductor	ABC'S DWG NO.	HE0420□□□□S□-□□□		
		REV.	20200519-D	PAGE	1

## I . Configuration and dimensions :

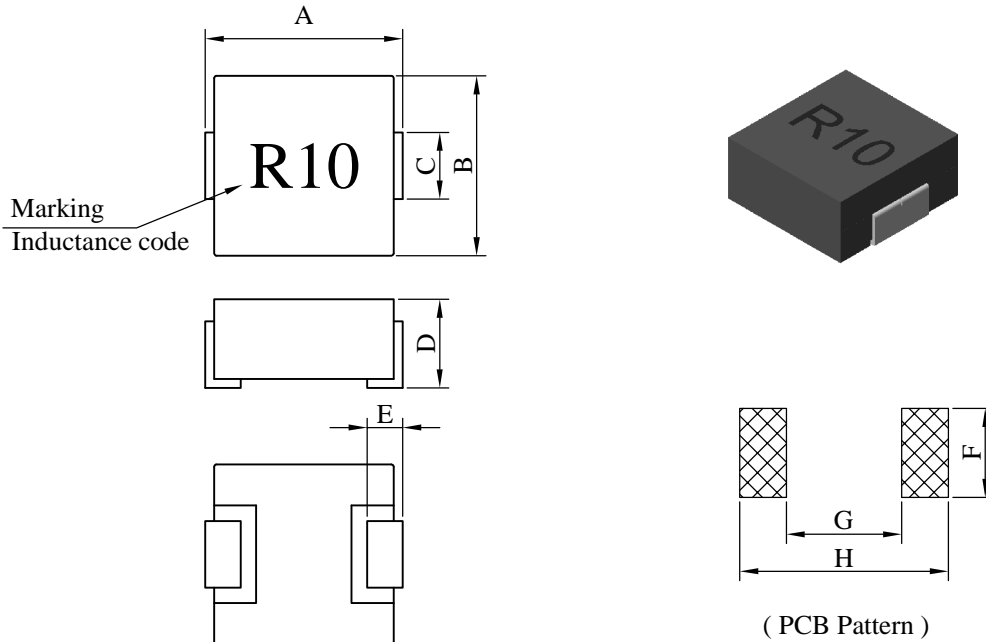

Unit : mm

A	B	C	D	E	F	G	H
4.45 ±0.25	4.05 ±0.25	1.50 ±0.30	2.00 max.	0.80 ±0.30	2.00 ref.	2.60 ref.	4.70 ref.

## II . Description :

- a . Powder molding construction.
- b . Magnetically shielded.
- c . Enamelled copper wire : N class
- d . Product weight : 0.18g ( ref. )
- e . Moisture sensitivity Level 2a
- f . Products comply with RoHS' requirements
- g . Halogen free

## III . General specification :

- a . Storage temp. : -55°C ~ +125°C
- b . Operating temp. : -55°C ~ +125°C  
( Temp. rise included )
- c . Resistance to solder heat : 260°C . 10 sec.

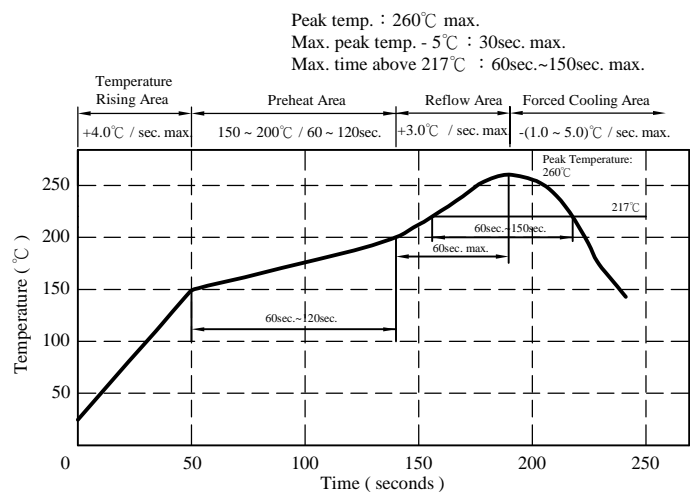

AR-001C

# SPECIFICATION FOR APPROVAL

REF. :

PROD. NAME	Shielded SMD Power Inductor	ABC'S DWG NO.	HE0420□□□□S□-□□□		
		REV.	20200519-D	PAGE	2

IV . Electrical characteristics :

DWG. No.	Inductance ( μH )	RDC ( mΩ )		Isat ( A ) typ.	Irms ( A ) typ.
		typ.	max.		
HE0420R10MS□-□□□	0.10 ±20%	3.5	4.0	22.0	12.0
HE0420R22MS□-□□□	0.22 ±20%	6.0	6.6	12.5	9.0
HE0420R33MS□-□□□	0.33 ±20%	9.6	13.0	12.0	8.0
HE0420R47MS□-□□□	0.47 ±20%	12.5	14.0	10.5	7.0
HE0420R56MS□-□□□	0.56 ±20%	14.0	16.0	10.0	6.5
HE0420R68MS□-□□□	0.68 ±20%	16.0	18.0	9.0	6.0
HE04201R0MS□-□□□	1.00 ±20%	24.0	27.0	7.0	4.5
HE04202R2MS□-□□□	2.20 ±20%	52.0	58.0	5.0	3.0
HE04203R3MS□-□□□	3.30 ±20%	74.0	87.0	4.0	2.5
HE04204R7MS□-□□□	4.70 ±20%	98.0	110.0	3.5	2.0
HE04205R6MS□-□□□	5.60 ±20%	105.0	115.0	3.0	1.8
HE04206R8MS□-□□□	6.80 ±20%	160.0	175.0	2.5	1.5

- 1). Electrical specifications at 25°C
- 2). Inductance Test Condition. :500kHz / 0.25V
- 3). Isat base on ΔL / L0A=30% typ.(Approximately transient current)
- 4). Irms base on Temp. rise 40°C typ.
- 5). Rated Voltage : 50V max.

# SPECIFICATION FOR APPROVAL

REF. :

PROD. NAME	Shielded SMD Power Inductor	ABC'S DWG NO.	HE0420□□□□S□-□□□		
		REV.	20200519-D	PAGE	3

V . Curve :

HE0420R10MS□

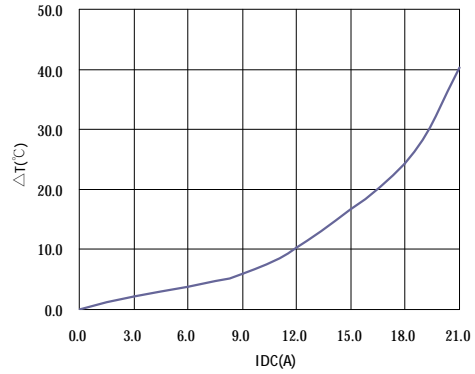
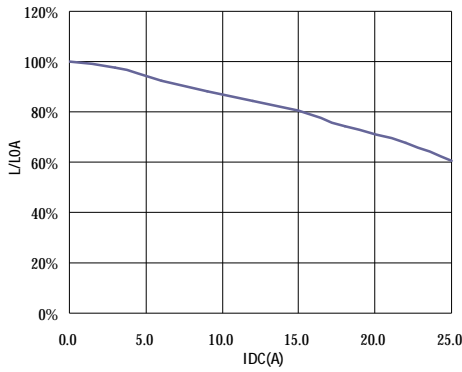

HE04201R0MS□

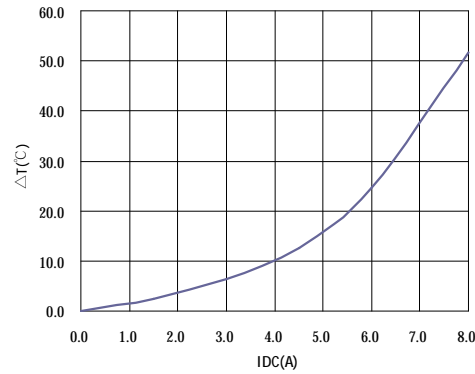
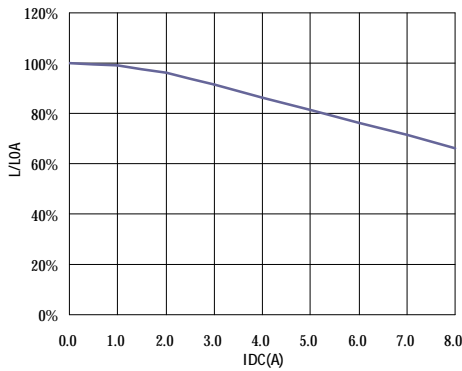

HE04204R7MS□

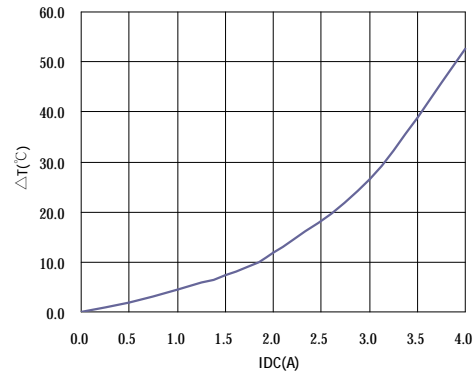
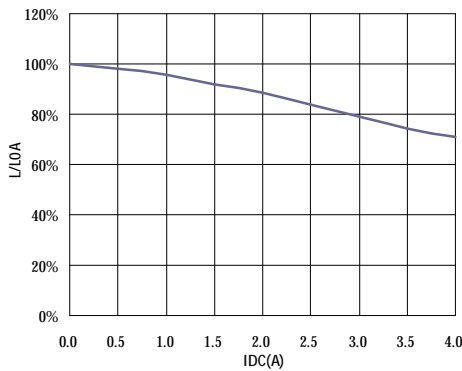

AR-001C

# SPECIFICATION FOR APPROVAL

REF. :

PROD. NAME	Shielded SMD Power Inductor	ABC'S DWG NO.	HE0420□□□□S□-□□□		
		REV.	20200519-D	PAGE	4

## VI . Packaging information :

### ( 1 ) Configuration

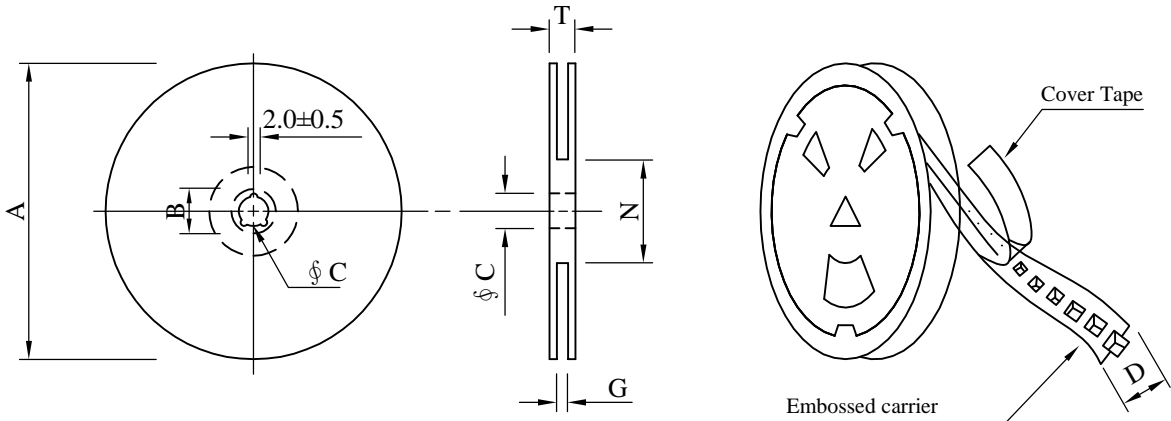

※Carrier tape width : D

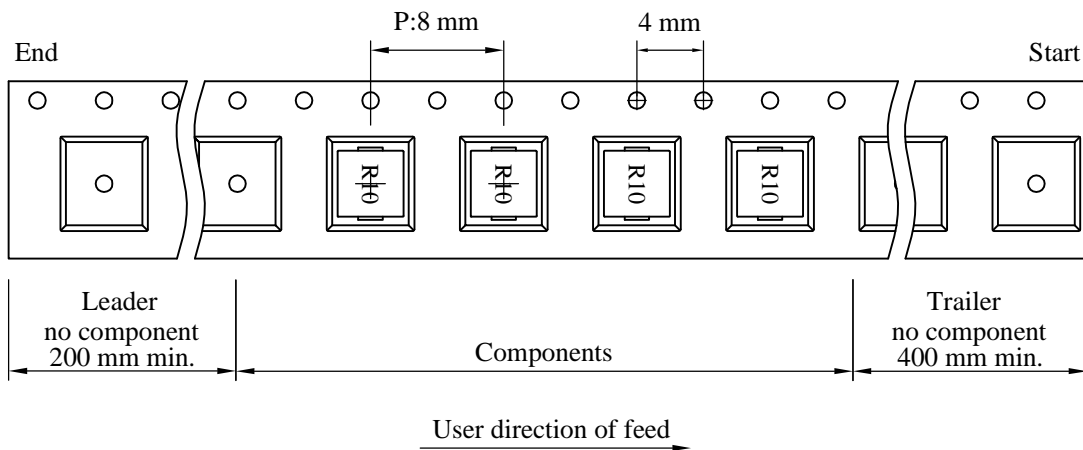

### ( 2 ) Dimensions

Unit:mm

Style	A	B	C	D	G	N	T
13 - 12	330	21±0.8	13±0.5	12	14 <sup>+0</sup>	50 <sup>-0</sup>	18.4

### ( 3 ) Q'TY & G.W. Per package

Code	Inner : Reel			Outer : Carton		
	Q'TY (pcs)	G.W. (g)	Style	Q'TY (pcs)	G.W. (kg)	Size (cm)
B	2,000	650	13 - 12	8,000	4.00	38 x 37 x 22

AR-001C



# SPECIFICATION FOR APPROVAL

REF. :

<b>PROD. NAME</b>	Shielded SMD Power Inductor	<b>ABC'S DWG NO.</b>	HE0420□□□□S□-□□□		
		<b>REV.</b>	20200519-D	<b>PAGE</b>	6

### VIII . Reliability test :

Item	Reference documents	Test Condition	Test Specification
1.High Temperature Exposure	MIL-STD-202 Method 108	1.Temperature: 125±2℃ 2.Time:96±2 hours.	1.No mechanical or electrical damage. 2.Inductance shall not change more than ±20%.
2.Temperature Cycling	JESD22-A 104	1.Temperature: -40℃ ~ +125℃ 2.Number of cycle:100 cycle 3.Dwell time:30 minutes	1.No mechanical or electrical damage. 2.Inductance shall not change more than ±20%.
3.Biased Humidity Test	MIL-STD-202 Method 103	1.Temperature : 85±2 ℃ 2.Humidity: 85% RH. 3.Time:96±2 Hours	1.No mechanical or electrical damage. 2.Inductance shall not change more than ±20%.
4.Operational Life	JESD22-A 108	1.Temperature: 125℃ (Temp. rise included) 2.Time:96±2 hours. 3.Rated current	1.No mechanical or electrical damage. 2.Inductance shall not change more than ±20%.
5.External Visual	JESD22-B 101 & MIL-STD-883 Method 2009	Inspect product constructions, marking and workmanship.	1.No pollution on the surface of products. 2.Clear marking. 3.No crack.
6.Physical Dimensions	JESD22-B 100	Verify physical dimensions to the applicable product detail specification.	Per product specification standard
7.Resistance to solvents	MIL-STD-202 Method 215	Immerse into solvent for 3±0.5 minutes & brush 10 times for 3 cycles.	1.No body change in apperance. 2.No marking blurred. 3.Inductance shall not change more than ±20%.
8.Vibration Test	MIL-STD-202 Method 204	1.Frequency and Amplitud : 10-2000-10 Hz, 1.5 mm. 2.Direction:X, Y, Z 3.Test duration:2 hours for each direction, 6 hours in total.	1.No mechanical or electrical damage. 2.Inductance shall not change more than ±20%.
9.Resistance To Soldering Heat Test	MIL-STD-202 Method 210 & J-STD020D.1	1.Highest temperature : 260±5℃. 2.Time ( temp. ≥ 217℃ ) : 60~150 Seconds. 3.IR reflow times : 3 times.	1.No mechanical or electrical damage. 2.Inductance shall not change more than ±20%.
10.Saturation Current	JIS C 6436 & User SPEC.	1.Applied rated current for 5 seconds. 2.Saturation current	Inductance shall not drop more than 30% typ.
11.Over load	JIS C 6436 & User SPEC.	1.Applied one and half rated current for a period of 5 minutes. 2.Rated current	No electrical or mechanical damage
12.Temperature Rise Current	JIS C 6436 & User SPEC.	1.Applied rated current for 10 minutes. 2.Temperature measure by digital surface thermometer. 3.Irms current	Surface temperature rise is less than 40℃ typ.
13.Solderability Test	J-STD-002 & JESD22-B 102	1.Baking in pre-testing : 150±5℃ / 16Hours±30 min. 2.Peak temperature : 240±5℃ 3.Time ( temp. ≥ 217℃ ) : 60~150 seconds. 4.IR reflow times : 1 time.	More than 95% soldering coverage min on terminations.
14.Electrical Characteriazation	MIL-STD-202 Method 304 & User SPEC.	1.Operating temperature : -55℃~125℃ 2.Room temperature : 25℃.	1.No mechanical or electrical damage. 2.Inductance shall not change more than ±20%.
15.Drop	CNS-C6354 & GB/T 2423.8	1.Products shall be mounted on SPEC. PCB and dropped down from a height of 1m 2.Drop total time : 6 times (Every side of sample drop 2 times)	1. Adhesion on PCB shall be enough. 2. Product appearance shall not break. 3. No electrical damage.
16.Terminal Strength Test	IEC 60068-2-21	1.Apply push force to samples mounted on PCB. 2.Force of 1.8 kg for 60±1 seconds.	After test, inductors shall be no mechanical damage.

AR-001C