

SPECIFICATION FOR APPROVAL

REF. :

PROD. NAME	Shielded SMD Power Inductor	ABC'S DWG NO.		HE0630□□□□S□-□□□	
		REV.	20200330-D	PAGE	1

I . Configuration and dimensions :

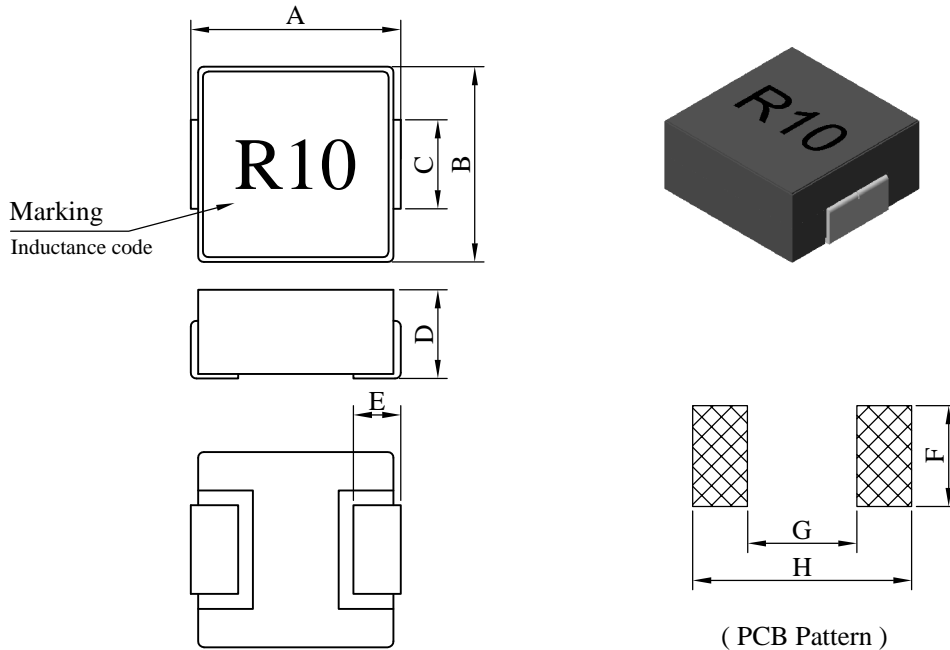

Unit : mm

A	B	C	D	E	F	G	H
7.10 ±0.30	6.60 ±0.30	3.00 ±0.30	3.00 max.	1.60 ±0.50	3.40 ref.	3.70 ref.	7.40 ref.

II . Description :

- a . Powder molding construction
- b . Magnetically shielded
- c . Enamelled copper wire : N class
- d . Product weight : 0.75g (ref.)
- e . Moisture sensitivity Level 2a
- f . Products comply with RoHS' requirements
- g . Halogen free

III . General specification :

- a . Storage temp. : -55°C ~ +125°C
- b . Operating temp. : -55°C ~ +125°C
(Temp. rise included)
- c . Resistance to solder heat : 260°C. 10 secs.

Peak Temp : 250°C max.
 Max. Peak Temp - 5°C : 30sec max.
 Max time above 217°C : 60sec~150sec max.

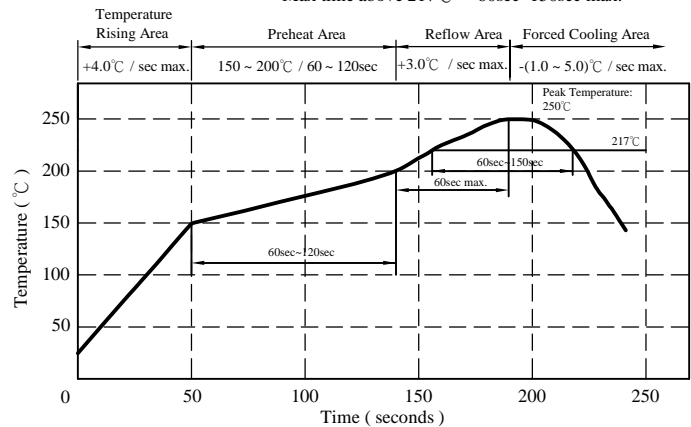

AR-001C

SPECIFICATION FOR APPROVAL

REF. :

PROD. NAME	Shielded SMD Power Inductor	ABC'S DWG NO.	HE0630□□□□S□-□□□		
		REV.	20200330-D	PAGE	2

IV . Electrical characteristics :

DWG. No.	Inductance (uH)	RDC (mΩ)		Isat (A) typ.	Irms (A) typ.
		typ.	max.		
HE0630R10MS□-□□□	0.10 ±20%	1.5	1.7	60.0	32.5
HE0630R15MS□-□□□	0.15 ±20%	1.9	2.5	52.0	26.0
HE0630R20MS□-□□□	0.20 ±20%	2.4	3.0	41.0	24.0
HE0630R22MS□-□□□	0.22 ±20%	2.5	2.8	40.0	23.0
HE0630R33MS□-□□□	0.33 ±20%	3.5	3.9	28.0	20.0
HE0630R47MS□-□□□	0.47 ±20%	4.0	4.2	26.0	17.5
HE0630R56MS□-□□□	0.56 ±20%	5.0	5.5	25.0	15.5
HE0630R68MS□-□□□	0.68 ±20%	5.0	5.5	23.5	15.5
HE0630R82MS□-□□□	0.82 ±20%	6.7	8.0	23.0	13.0
HE06301R0MS□-□□□	1.00 ±20%	9.0	10.0	22.0	11.0
HE06301R5MS□-□□□	1.50 ±20%	14.0	15.0	18.0	9.0
HE06302R2MS□-□□□	2.20 ±20%	18.0	20.0	14.0	8.0
HE06303R3MS□-□□□	3.30 ±20%	28.0	30.0	13.5	6.0
HE06304R7MS□-□□□	4.70 ±20%	37.0	40.0	9.5	5.5
HE06305R6MS□-□□□	5.60 ±20%	52.0	60.0	9.0	4.8
HE06306R8MS□-□□□	6.80 ±20%	54.0	60.0	8.0	4.5
HE06308R2MS□-□□□	8.20 ±20%	64.0	68.0	7.5	4.0
HE0630100MS□-□□□	10.00 ±20%	102.0	105.0	7.0	3.0

- 1). Electrical specifications at 25°C
- 2). Inductance Test Condition. :500kHz / 0.25V
- 3). Isat base on ΔL / L0A=30% typ.(Approximately transient current)
- 4). Irms base on Temp. rise 40°C typ.
- 5). Rated Voltage : 50V max.

SPECIFICATION FOR APPROVAL

REF. :

PROD. NAME	Shielded SMD Power Inductor	ABC'S DWG NO.	HE0630□□□□S□-□□□		
		REV.	20200330-D	PAGE	3

V . Curve :

HE0630R10MS□

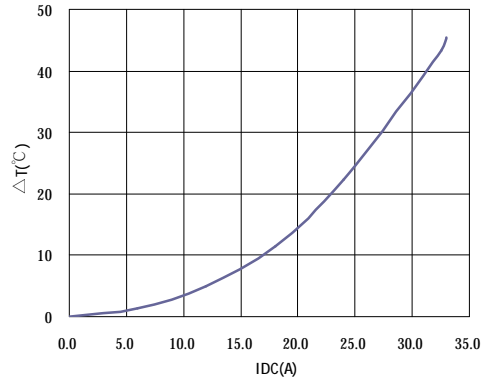
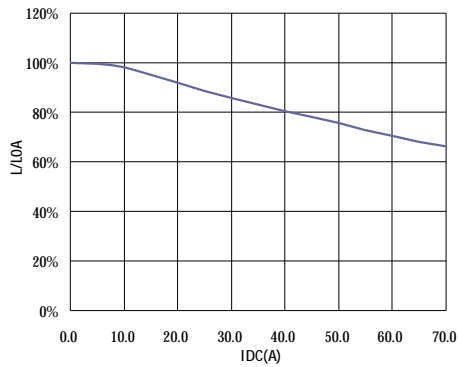

HE06301R0MS□

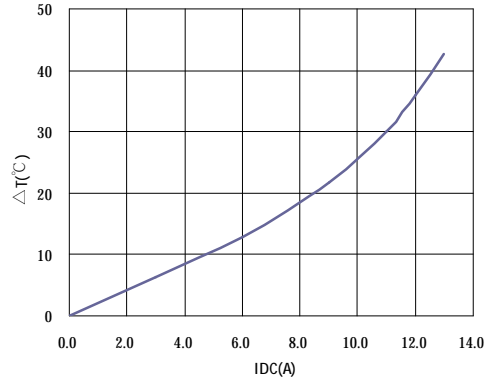
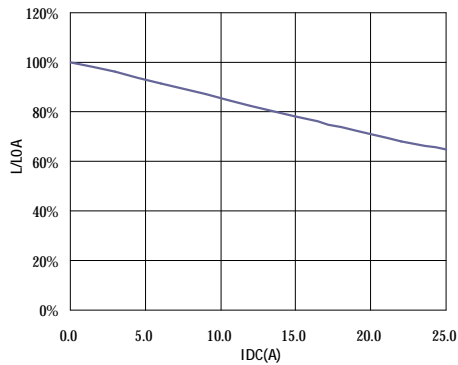

HE06308R2MS□

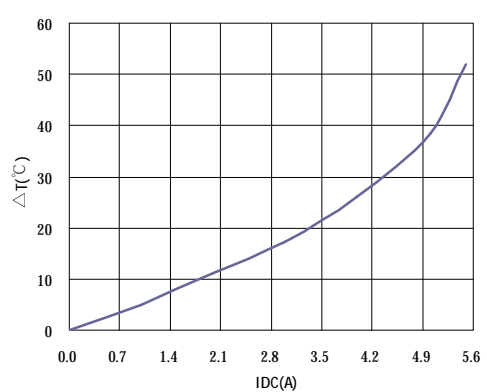
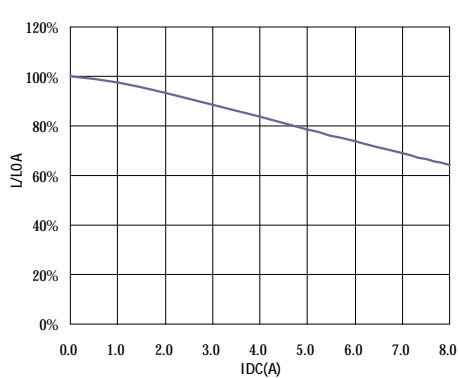

AR-001C

SPECIFICATION FOR APPROVAL

REF. :

PROD. NAME	Shielded SMD Power Inductor	ABC'S DWG NO.		HE0630□□□□S□-□□□	
		REV.	20200330-D	PAGE	4

VI . Packaging information :

(1) Configuration

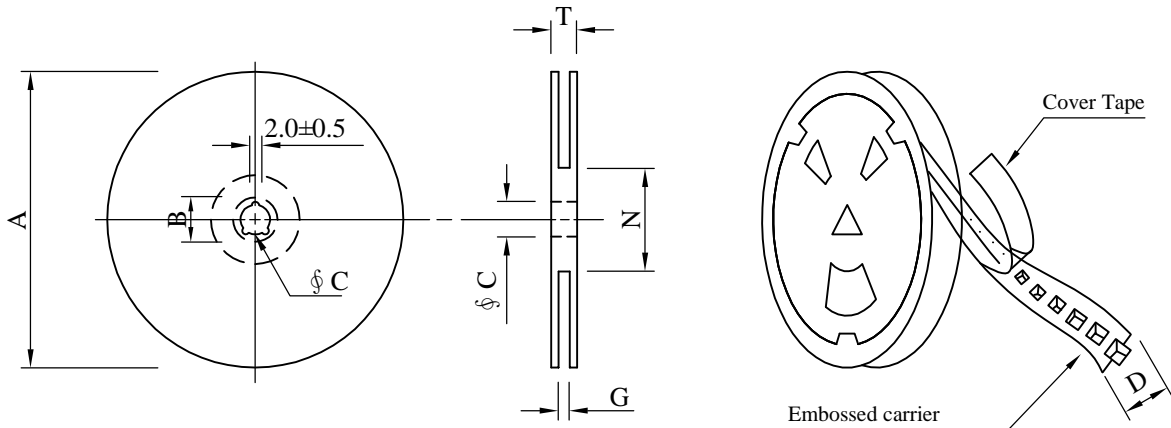

※Carrier tape width : D

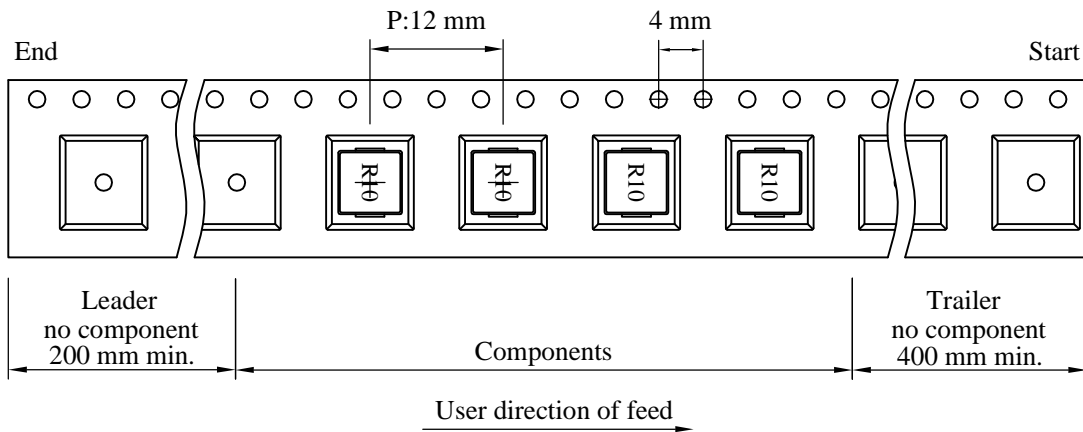

(2) Dimensions

Unit:mm

Style	A	B	C	D	G	N	T
13 - 16	330	21±0.8	13±0.5	16	18 ⁺⁰	50 ⁻⁰	22.4

(3) Q'TY & G.W. Per package

Code	Inner : Reel			Outer : Carton		
	Q'TY (pcs)	G.W. (g)	Style	Q'TY (pcs)	G.W. (kg)	Size (cm)
B	1,000	1,100	13 - 16	4,000	6.00	38 x 37 x 22

AR-001C

SPECIFICATION FOR APPROVAL

REF. :

PROD. NAME	Shielded SMD Power Inductor	ABC'S DWG NO.	HE0630□□□□S□-□□□		
		REV.	20200330-D	PAGE	5

VII . Drawing number expression :

H E 0 6 3 0 □ □ □ □ □ □ — □ □ □

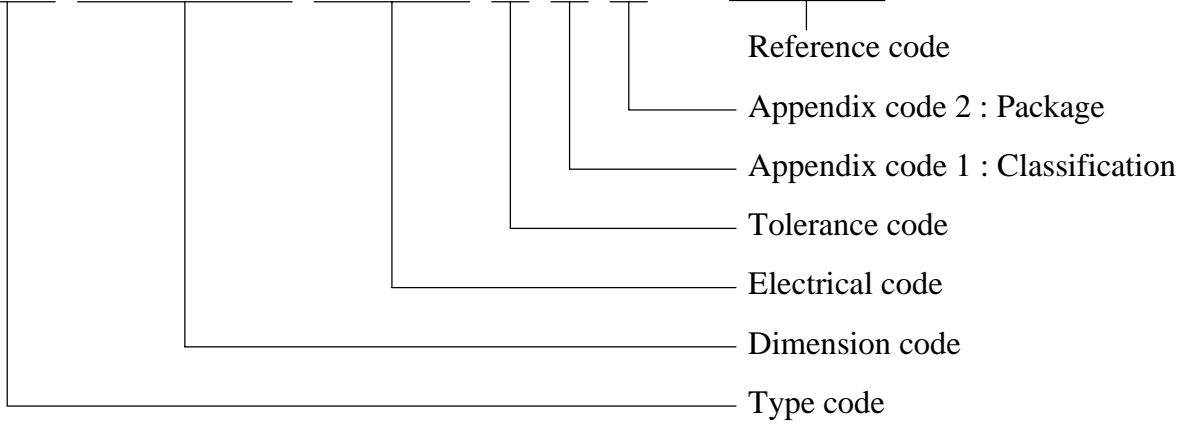

Appendix code 1 : Product Classification

Appendix code 2 : Package Information

Code	Inner package	Cover tape	Carrier tape	Bag	Package Q'TY	Remark
B	T/R (Reel package)	Adhesive	Non-antistatic	Non-antistatic	1,000 pcs	

SPECIFICATION FOR APPROVAL

REF. :

PROD. NAME	Shielded SMD Power Inductor	ABC'S DWG NO.	HE0630□□□□S□-□□□		
		REV.	20200330-D	PAGE	6

VIII . Reliability test :

Item	Reference documents	Test Condition	Test Specification
1.High Temperature Exposure	MIL-STD-202 Method 108	1.Temperature: 125±2℃ 2.Time:96±2 hours.	1.No mechanical or electrical damage. 2.Inductance shall not change more than ±20%.
2.Temperature Cycling	JESD22-A 104	1.Temperature: -40℃ ~ +125℃ 2.Number of cycle:100 cycle 3.Dwell time:30 minutes	1.No mechanical or electrical damage. 2.Inductance shall not change more than ±20%.
3.Biased Humidity Test	MIL-STD-202 Method 103	1.Temperature : 85±2 ℃ 2.Humidity: 85% RH. 3.Time:96±2 Hours	1.No mechanical or electrical damage. 2.Inductance shall not change more than ±20%.
4.Operational Life	JESD22-A 108	1.Temperature: 125℃ (Temp. rise included) 2.Time:96±2 hours. 3.Rated current	1.No mechanical or electrical damage. 2.Inductance shall not change more than ±20%.
5.External Visual	JESD22-B 101 & MIL-STD-883 Method 2009	Inspect product constructions, marking and workmanship.	1.No pollution on the surface of products. 2.Clear marking. 3.No crack.
6.Physical Dimensions	JESD22-B 100	Verify physical dimensions to the applicable product detail specification.	Per product specification standard
7.Resistance to solvents	MIL-STD-202 Method 215	Immerse into solvent for 3±0.5 minutes & brush 10 times for 3 cycles.	1.No body change in apperance. 2.No marking blurred. 3.Inductance shall not change more than ±20%.
8.Vibration Test	MIL-STD-202 Method 204	1.Frequency and Amplitud : 10-2000-10 Hz, 1.5 mm. 2.Direction:X, Y, Z 3.Test duration:2 hours for each direction, 6 hours in total.	1.No mechanical or electrical damage. 2.Inductance shall not change more than ±20%.
9.Resistance To Soldering Heat Test	MIL-STD-202 Method 210 & J-STD020D.1	1.Highest temperature : 250±5℃. 2.Time (temp. ≥ 217℃) : 60~150 Seconds. 3.IR reflow times : 3 times.	1.No mechanical or electrical damage. 2.Inductance shall not change more than ±20%.
10.Saturation Current	JIS C 6436 & User SPEC.	1.Applied rated current for 5 seconds. 2.Saturation current	Inductance shall not drop more than 30% typ.
11.Over load	JIS C 6436 & User SPEC.	1.Applied one and half rated current for a period of 5 minutes. 2.Rated current	No electrical or mechanical damage
12.Temperature Rise Current	JIS C 6436 & User SPEC.	1.Applied rated current for 10 minutes. 2.Temperature measure by digital surface thermometer. 3.Irms current	Surface temperature rise is less than 40℃ typ.
13.Solderability Test	J-STD-002 & JESD22-B 102	1.Baking in pre-testing : 150±5℃ / 16Hours±30 min. 2.Peak temperature : 240±5℃ 3.Time (temp. ≥ 217℃) : 60~150 seconds. 4.IR reflow times : 1 time.	More than 95% soldering coverage min on terminations.
14.Electrical Characteriazation	MIL-STD-202 Method 304 & User SPEC.	1.Operating temperature : -55℃~125℃ 2.Room temperature : 25℃.	1.No mechanical or electrical damage. 2.Inductance shall not change more than ±20%.
15.Drop	CNS-C6354 & GB/T 2423.8	1.Products shall be mounted on SPEC. PCB and dropped down from a height of 1m 2.Drop total time : 6 times (Every side of sample drop 2 times)	1. Adhesion on PCB shall be enough. 2. Product appearance shall not break. 3. No electrical damage.
16.Terminal Strength Test	IEC 60068-2-21	1.Apply push force to samples mounted on PCB. 2.Force of 1.8 kg for 60±1 seconds.	After test, inductors shall be no mechanical damage.

AR-001C