

SPECIFICATION FOR APPROVAL

REF. :

PROD. NAME	Shielded SMD Power Inductor	ABC'S DWG NO.	HE1040□□□□L□-□□□		
		REV.	20200519-D	PAGE	1

I . Configuration and dimensions :

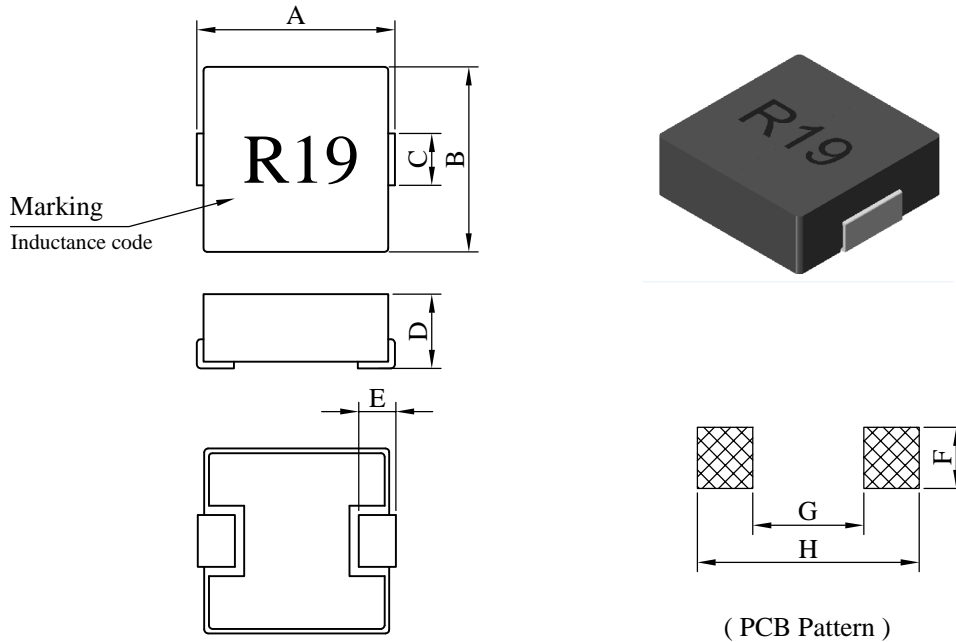

Unit : mm

A	B	C	D	E	F	G	H
11.50 max.	10.00 ±0.30	2.80 ±0.50	4.00 max.	2.00 ±0.50	3.30 ref.	6.00 ref.	12.00 ref.

II . Description :

- a . Powder molding construction
- b . Magetically shielded
- c . Enamelled copper wire : N class
- d . Product weight : 2.30g (ref.)
- e . Moisture sensitivity Level 2a
- f . Products comply with RoHS' requirements
- g . Halogen free

III . General specification :

- a . Storage temp. : -55°C ~ +125°C
- b . Operating temp. : -55°C ~ +125°C
(Temp. rise included)
- c . Resistance to solder heat : 260°C. 10 sec.

Peak temp. : 245°C max.
Max. peak temp. -5°C : 30sec. max.
Max. time above 217°C : 60sec.~150sec. max.

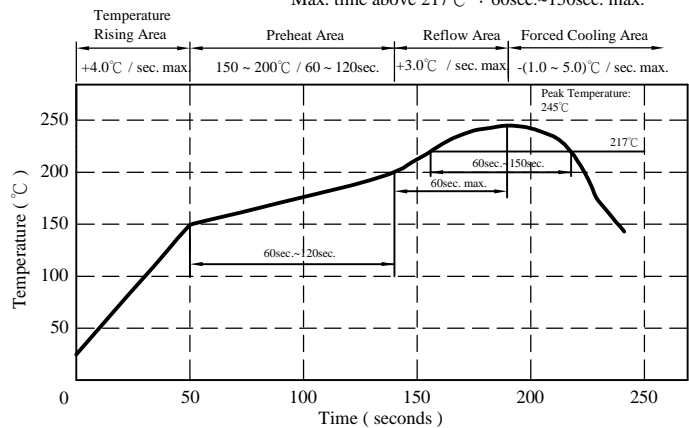

AR-001C

SPECIFICATION FOR APPROVAL

REF. :

PROD. NAME	Shielded SMD Power Inductor	ABC'S DWG NO.	HE1040□□□□L□-□□□		
		REV.	20200519-D	PAGE	2

IV . Electrical characteristics :

DWG No.	Inductance (μH)	RDC (mΩ)		Isat (A) typ.	Irms (A) typ.
		typ.	max.		
HE1040R19ML□-□□□	0.19 ±20%	0.50	0.70	44.0	44.0
HE1040R22ML□-□□□	0.22 ±20%	0.60	0.80	42.0	38.0
HE1040R24ML□-□□□	0.24 ±20%	0.70	0.80	38.0	38.0
HE1040R36ML□-□□□	0.36 ±20%	0.85	0.95	35.0	35.0
HE1040R41ML□-□□□	0.41 ±20%	1.04	1.15	32.0	33.0
HE1040R47ML□-□□□	0.47 ±20%	1.20	1.40	32.0	32.0
HE1040R56ML□-□□□	0.56 ±20%	1.30	1.50	30.0	30.0
HE1040R68ML□-□□□	0.68 ±20%	1.60	1.80	30.0	25.0
HE1040R78ML□-□□□	0.78 ±20%	1.60	1.80	25.0	25.0
HE1040R82ML□-□□□	0.82 ±20%	2.20	2.50	21.0	21.0
HE10401R0ML□-□□□	1.00 ±20%	2.20	2.50	21.0	21.0
HE10401R8ML□-□□□	1.80 ±20%	4.50	5.00	15.0	15.0
HE10402R0ML□-□□□	2.00 ±20%	5.20	5.80	14.0	14.0
HE10402R2ML□-□□□	2.20 ±20%	5.50	6.30	13.0	14.0
HE10402R5ML□-□□□	2.50 ±20%	8.20	9.00	12.0	12.0
HE10403R3ML□-□□□	3.30 ±20%	8.20	9.00	11.0	12.0

- 1). Electrical specifications at 25°C
- 2). Inductance Test Condition. :500kHz / 0.25V
- 3). Isat base on ΔL / L0A=30% typ.(Approximately transient current)
- 4). Irms base on Temp. rise 40°C typ.
- 5). Rated Voltage : 50V max.

SPECIFICATION FOR APPROVAL

REF. :

PROD. NAME	Shielded SMD Power Inductor	ABC'S DWG NO.	HE1040□□□□L□-□□□		
		REV.	20200519-D	PAGE	3

V . Curve :

HE1040R19ML□

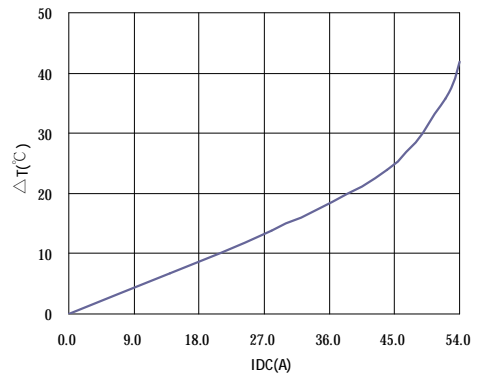
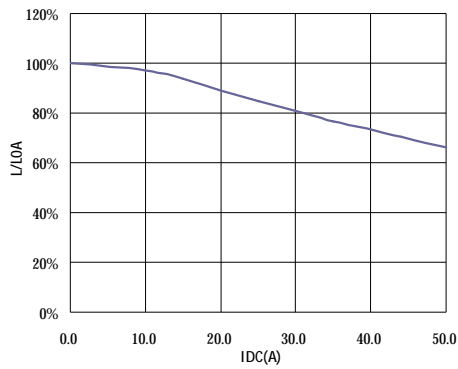

HE1040R82ML□

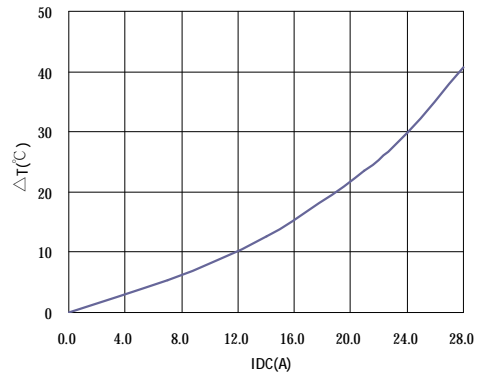
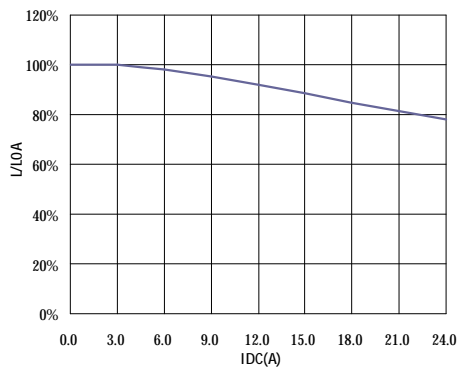

HE10403R3ML□

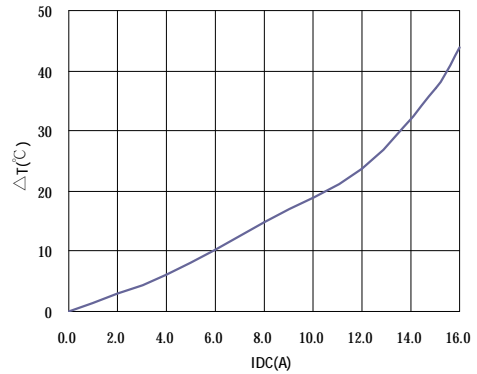
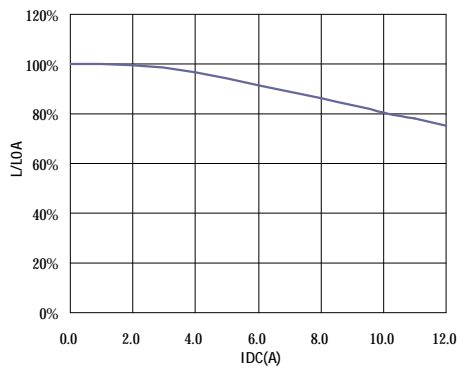

AR-001C

SPECIFICATION FOR APPROVAL

REF. :

PROD. NAME	Shielded SMD Power Inductor	ABC'S DWG NO.	HE1040□□□□L□-□□□		
		REV.	20200519-D	PAGE	4

VI . Packaging information :

(1) Configuration

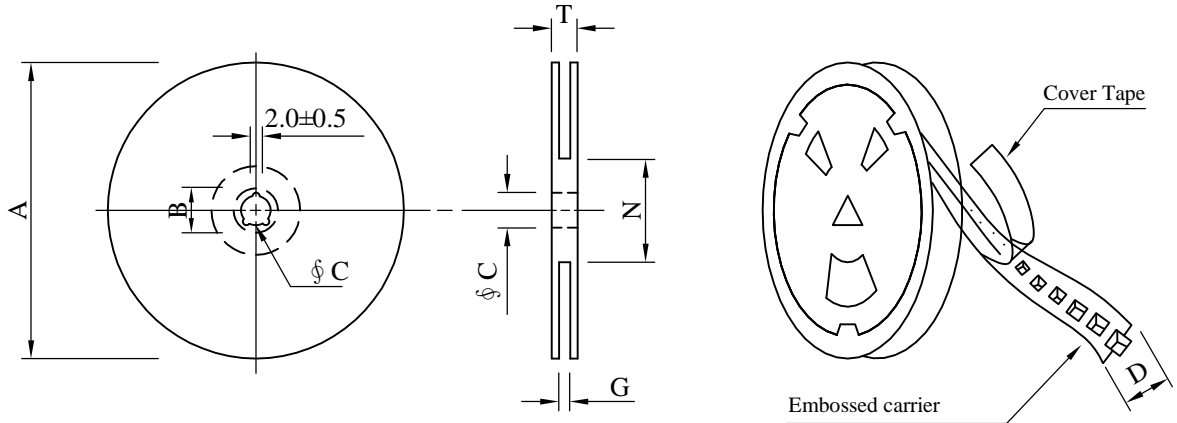

※Carrier tape width : D

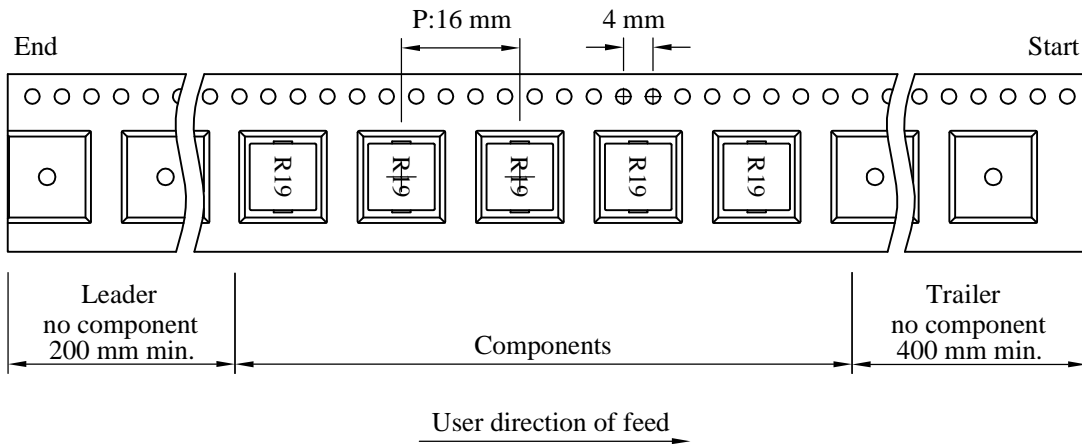

(2) Dimensions

Unit:mm

Style	A	B	C	D	G	N	T
13 - 24	330	21±0.8	13±0.5	24	26 ⁺⁰	60 ⁻⁰	30.4

(3) Q'TY & G.W. Per package

Code	Inner : Reel			Outer : Carton		
	QTY (pcs)	G.W. (g)	Style	QTY (pcs)	G.W. (kg)	Size (cm)
B	800	2,400	13 - 24	3,200	11.00	38 x 37 x 22

AR-001C

SPECIFICATION FOR APPROVAL

REF. :

PROD. NAME	Shielded SMD Power Inductor	ABC'S DWG NO.	HE1040□□□□L□-□□□		
		REV.	20200519-D	PAGE	5

VII . Drawing number expression :

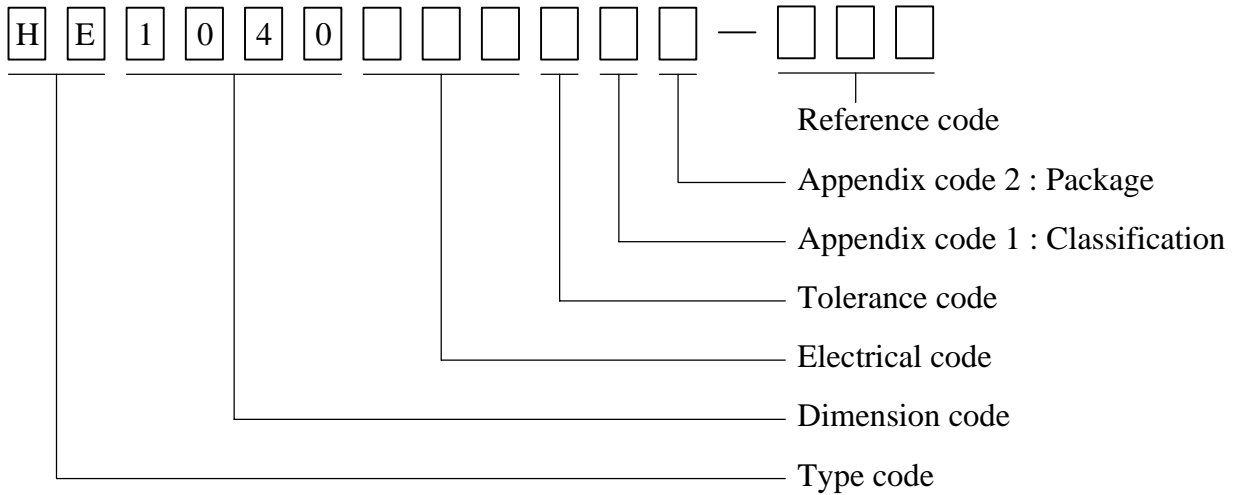

Appendix code 1 : Product Classification

Appendix code 2 : Package Information

Code	Inner package	Cover tape	Carrier tape	Bag	Package Q'TY	Remark
B	T/R (Reel package)	Adhesive	Non-antistatic	Non-antistatic	800 pcs	

AR-001C

SPECIFICATION FOR APPROVAL

REF. :

PROD. NAME	Shielded SMD Power Inductor	ABC'S DWG NO.	HE1040□□□□L□-□□□		
		REV.	20200519-D	PAGE	6

VIII . Reliability test :

Item	Reference documents	Test Condition	Test Specification
1.High Temperature Exposure	MIL-STD-202 Method 108	1.Temperature: 125±2℃ 2.Time:96±2 hours.	1.No mechanical or electrical damage. 2.Inductance shall not change more than ±20%.
2.Temperature Cycling	JESD22-A 104	1.Temperature: -40℃ ~ +125℃ 2.Number of cycle:100 cycle 3.Dwell time:30 minutes	1.No mechanical or electrical damage. 2.Inductance shall not change more than ±20%.
3.Biased Humidity Test	MIL-STD-202 Method 103	1.Temperature : 85±2 ℃ 2.Humidity: 85% RH. 3.Time:96±2 Hours	1.No mechanical or electrical damage. 2.Inductance shall not change more than ±20%.
4.Operational Life	JESD22-A 108	1.Temperature: 125℃ (Temp. rise included) 2.Time:96±2 hours. 3.Rated current	1.No mechanical or electrical damage. 2.Inductance shall not change more than ±20%.
5.External Visual	JESD22-B 101 & MIL-STD-883 Method 2009	Inspect product constructions, marking and workmanship.	1.No pollution on the surface of products. 2.Clear marking. 3.No crack.
6.Physical Dimensions	JESD22-B 100	Verify physical dimensions to the applicable product detail specification.	Per product specification standard
7.Resistance to solvents	MIL-STD-202 Method 215	Immerse into solvent for 3±0.5 minutes & brush 10 times for 3 cycles.	1.No body change in apperance. 2.No marking blurred. 3.Inductance shall not change more than ±20%.
8.Vibration Test	MIL-STD-202 Method 204	1.Frequency and Amplitud : 10-2000-10 Hz, 1.5 mm. 2.Direction:X, Y, Z 3.Test duration:2 hours for each direction, 6 hours in total.	1.No mechanical or electrical damage. 2.Inductance shall not change more than ±20%.
9.Resistance To Soldering Heat Test	MIL-STD-202 Method 210 & J-STD020D.1	1.Highest temperature : 245±5℃. 2.Time (temp. ≥ 217℃) : 60~150 Second. 3.IR reflow times : 3 times.	1.No mechanical or electrical damage. 2.Inductance shall not change more than ±20%.
10.Saturation Current	JIS C 6436 & User SPEC.	1.Applied rated current for 5 second. 2.Saturation current	Inductance shall not drop more than 30% typ.
11.Over load	JIS C 6436 & User SPEC.	1.Applied one and half rated current for a period of 5 minutes. 2.Rated current	No electrical or mechanical damage
12.Temperature Rise Current	JIS C 6436 & User SPEC.	1.Applied rated current for 10 minutes. 2.Temperature measure by digital surface thermometer. 3.Irms current	Surface temperature rise is less than 40℃ typ.
13.Solderability Test	J-STD-002 & JESD22-B 102	1.Baking in pre-testing : 150±5℃ / 16Hours±30 min. 2.Peak temperature : 240±5℃ 3.Time (temp. ≥ 217℃) : 60~150 second. 4.IR reflow times : 1 times.	More than 95% soldering coverage min on terminations.
14.Electrical Characteriazation	MIL-STD-202 Method 304 & User SPEC.	1.Operating temperature : -55℃~125℃ 2.Room temperature : 25℃.	1.No mechanical or electrical damage. 2.Inductance shall not change more than ±20%.
15.Drop	CNS-C6354 & GB/T 2423.8	1.Products shall be mounted on SPEC. PCB and dropped down from a height of 1m 2.Drop total time : 6 time (Every side of sample drop 2 time)	1. Adhesion on PCB shall be enough. 2. Product appearance shall not break. 3. No electrical damage.
16.Terminal Strength Test	IEC 60068-2-21	1.Apply push force to samples mounted on PCB. 2.Force of 1.8 kg for 60±1 seconds.	After test, inductors shall be no mechanical damage.

AR-001C