

# SPECIFICATION FOR APPROVAL

REF. :

PROD. NAME	Shielded SMD Power Inductor	ABC'S DWG NO.		SU1038□□□□F□-□□□			
		REV.	20200722-K	PAGE	1		

**I . Configuration and dimensions :**

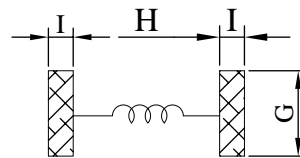
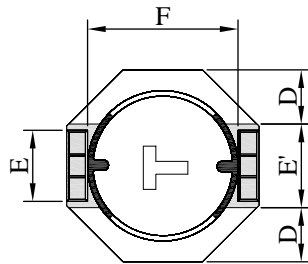
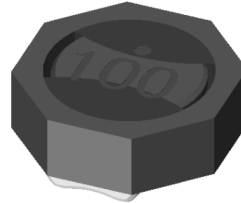
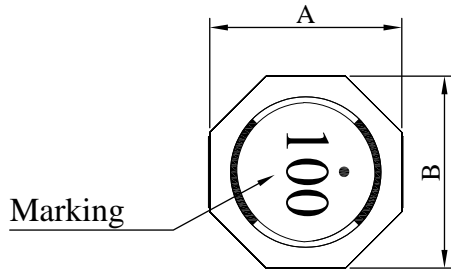

( PCB Pattern )

Unit : mm

A	B	C	D	E	E'	F	G	H	I
10.00 ±0.3	10.00 ±0.3	3.80 ±0.3	2.50 typ.	3.20 typ.	5.00 ±0.5	7.40 typ.	4.00 ref.	7.20 ref.	1.80 ref.

**II . Description :**

- a . Ferrite drum core construction
- b . Magnetically shielded
- c . Enamelled copper wire : F、H class
- d . Product weight : 1.26 g ( ref. )
- e . Moisture sensitivity Level 1
- f . Products comply with RoHS' requirements
- g . Halogen free

**III . General specification :**

- a . Storage temp. : -40°C ----+125°C
- b . Operating temp. : -40°C ----+125°C  
( Temp. rise included. )
- c . Resistance to solder heat : 260°C .10 sec.

Peak Temp. : 245°C max.  
Max. Peak Temp. - 5°C : 30sec. max.  
Max. time above 217°C : 60sec.~150sec. max.

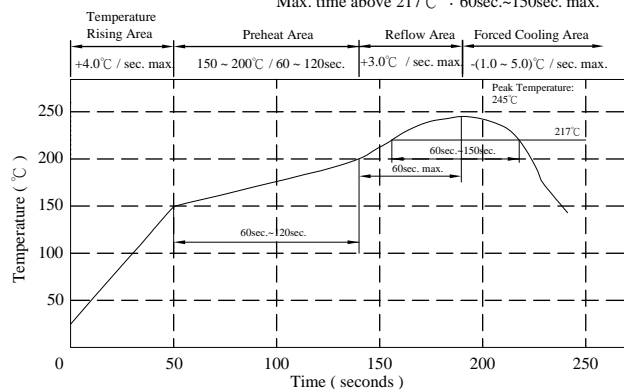

AR-001C

# SPECIFICATION FOR APPROVAL

REF. :

PROD. NAME	Shielded SMD Power Inductor	ABC'S DWG NO.	SU1038□□□□F□-□□□		
		REV.	20200722-K	PAGE	2

## IV . Electrical characteristics :

DWG. No.	Inductance ( $\mu$ H)	Q ref.	SRF (MHz) typ.	RDC (m $\Omega$ )		I <sub>rms</sub> (A) max.	I <sub>sat</sub> (A) typ.
				typ.	max.		
SU10381R5YF□-□□□	1.5 ± 30 %	14	65	5.2	7.5	7.20	7.00
SU10382R2YF□-□□□	2.2 ± 30 %	12	55	7.7	10.5	6.80	6.50
SU10383R5YF□-□□□	3.5 ± 30 %	14	35	11.5	15.0	5.50	5.50
SU10385R0YF□-□□□	5.0 ± 30 %	12	30	14.5	22.0	4.60	4.80
SU10386R2YF□-□□□	6.2 ± 30 %	12	25	16.5	24.0	4.00	4.20
SU1038100YF□-□□□	10.0 ± 30 %	24	20	25.0	35.0	3.80	3.60
SU1038150YF□-□□□	15.0 ± 30 %	24	16	37.0	50.0	2.80	2.70
SU1038220YF□-□□□	22.0 ± 30 %	20	12	55.8	75.0	2.20	2.30
SU1038330YF□-□□□	33.0 ± 30 %	22	10	86.0	112.0	1.80	1.80
SU1038470YF□-□□□	47.0 ± 30 %	22	8	121.0	160.0	1.65	1.60
SU1038680YF□-□□□	68.0 ± 30 %	24	7	166.0	216.0	1.30	1.30
SU1038101YF□-□□□	100.0 ± 30 %	24	6	220.0	300.0	1.10	1.10
SU1038151YF□-□□□	150.0 ± 30 %	20	5	358.0	476.0	0.90	0.80
SU1038221YF□-□□□	220.0 ± 30 %	22	4	565.0	740.0	0.65	0.65
SU1038331YF□-□□□	330.0 ± 30 %	20	3	773.0	1000.0	0.55	0.52

- 1). Electrical specifications at 25°C
- 2). Inductance Test Freq. : 100kHz / 1V
- 3). Q Test Freq. : 1R5~6R2--7.96MHz , 100~680--2.52MHz , 101~331--0.796MHz
- 4). I<sub>sat</sub> base on  $\Delta L / LOA=35\%$  typ.
- 5). I<sub>rms</sub> base on Temp. rise 40°C max.

AR-001C

# SPECIFICATION FOR APPROVAL

REF. :

PROD. NAME	Shielded SMD Power Inductor	ABC'S DWG NO.		SU1038□□□□F□-□□□	
		REV.	20200722-K	PAGE	3

V . Curve :

SU10383R5YF□

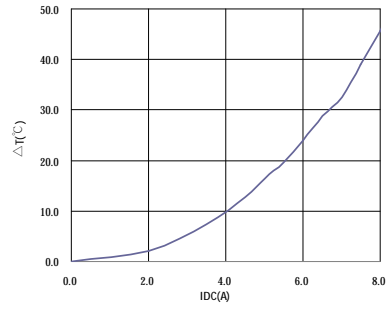
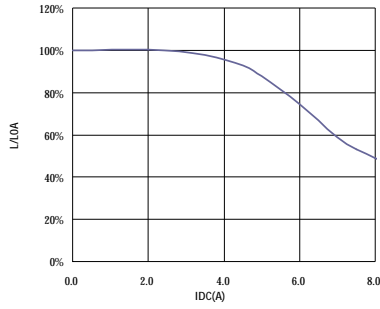

SU1038330YF□

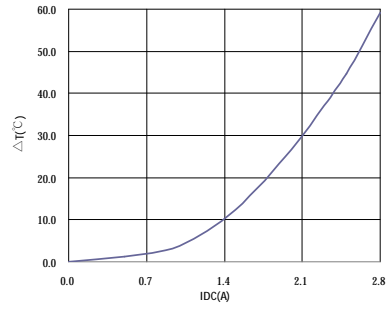
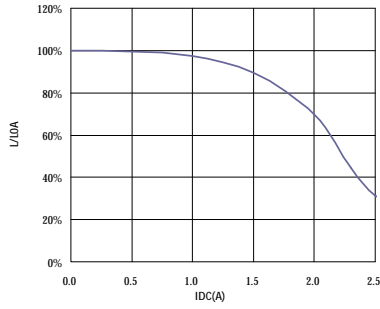

SU1038101YF□

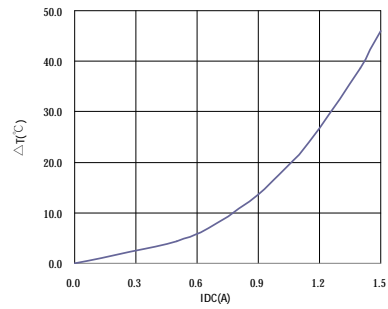
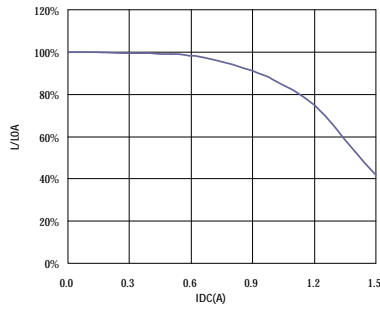

SU1038331YF□

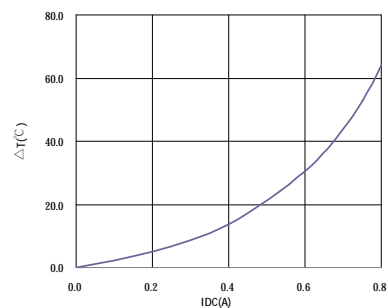
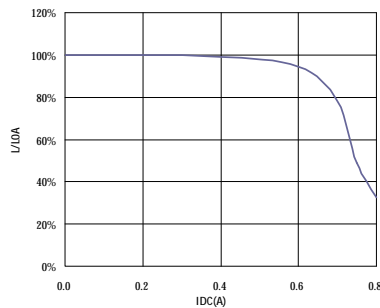

AR-001C

# SPECIFICATION FOR APPROVAL

REF. :

PROD. NAME	Shielded SMD Power Inductor	ABC'S DWG NO.		SU1038□□□□F□-□□□	
		REV.	20200722-K	PAGE	4

## VI . Packaging information :

### ( 1 ) Configuration

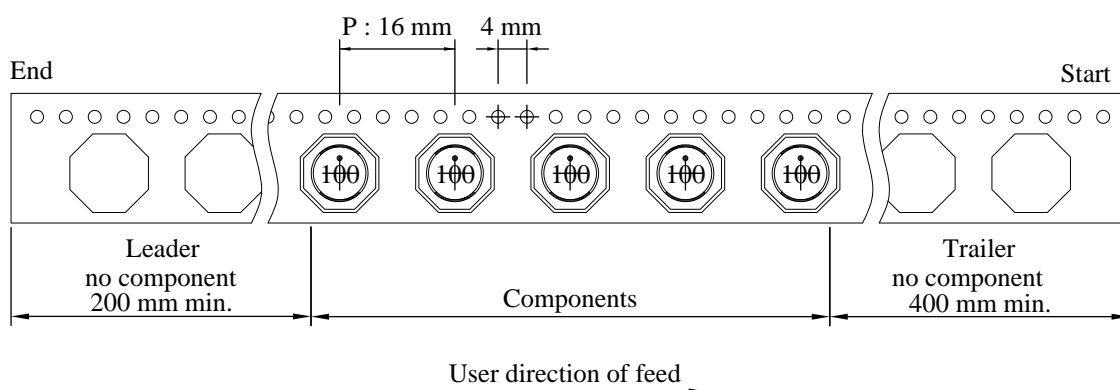
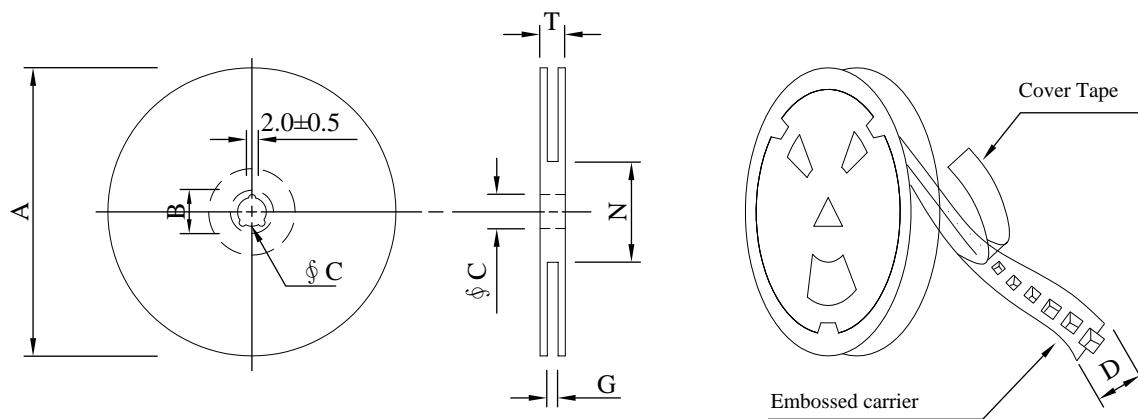

### ( 2 ) Dimensions

Unit:mm

Style	A	B	C	D	G	N	T
13 - 24	330	21±0.8	13±0.5	24	26 <sup>+0</sup>	60 <sup>-0</sup>	30.4

### ( 3 ) Q'TY & G.W. Per package

Code	Inner : Reel			Outer : Carton		
	Q'TY (pcs)	G.W. (g)	Style	Q'TY (pcs)	G.W. (kg)	Size (cm)
B	800	1480	13 - 24	3,200	7.2	38 x 37 x 22
C	1,000	1730	13 - 24	4,000	8.2	38 x 37 x 22

AR-001C

# SPECIFICATION FOR APPROVAL

REF. :

PROD. NAME	Shielded SMD Power Inductor	ABC'S DWG NO.	SU1038□□□□F□-□□□		
		REV.	20200722-K	PAGE	5

VII . Drawing number expression :

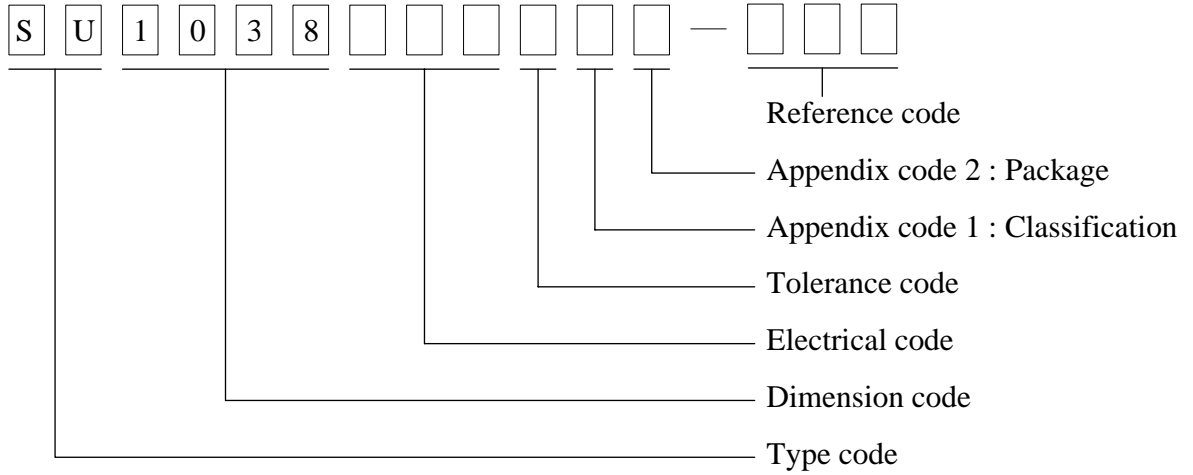

Appendix code 1 : Product Classification

Appendix code 2 : Package Information

Code	Inner package	Cover tape	Carrier tape	Bag	Package Q'TY	Remark
B	T/R (Reel package)	UCT	Antistatic	Antistatic	800 pcs	
C	T/R (Reel package)	UCT	Antistatic	Antistatic	1,000 pcs	

AR-001C

# SPECIFICATION FOR APPROVAL

REF. :

PROD. NAME	Shielded SMD Power Inductor	ABC'S DWG NO.	SU1038□□□□F□-□□□		
		REV.	20200722-K	PAGE	6

## VII . Reliability test :

Item	Reference documents	Test Condition	Test Specification
1.High Temperature Exposure	MIL-STD-202 Method 108	1.Temperature: 125±2℃ 2.Time:96±2 hours.	1.No mechanical or electrical damage. 2.Inductance shall not change more than ±20%.
2.Temperature Cycling	JESD22-A 104	1.Temperature: -40℃ ~ +125℃ 2.Number of cycle:100 cycles 3.Dwell time:30 minutes	1.No mechanical or electrical damage. 2.Inductance shall not change more than ±20%.
3.Biased Humidity Test	MIL-STD-202 Method 103	1.Temperature : 85±2 ℃ 2.Humidity: 85% RH. 3.Time:96±2 Hours	1.No mechanical or electrical damage. 2.Inductance shall not change more than ±20%.
4.Operational Life	JESD22-A 108	1.Temperature: 125℃(Temp. rise included) 2.Time:96±2 hours. 3.Rated current	1.No mechanical or electrical damage. 2.Inductance shall not change more than ±20%.
5.External Visual	JESD22-B 101 & MIL-STD-883 Method 2009	Inspect product constructions, marking and workmanship.	1.No pollution on the surface of products. 2.Clear marking. 3.No crack.
6.Physical Dimensions	JESD22-B 100	Verify physical dimensions to the applicable product detail specification.	Per product specification standard
7.Resistance to solvents	MIL-STD-202 Method 215	Immerse into solvent for 3±0.5 minutes & brush 10 times for 3 cycles.	1.No body change in appearance. 2.No marking blurred. 3.Inductance shall not change more than ±20%.
8.Vibration Test	MIL-STD-202 Method 204	1.Frequency and Amplitued : 10-2000-10 Hz, 1.5 mm. 2.Direction:X, Y, Z 3.Test duration:2 hours for each direction, 6 hours in total.	1.No mechanical or electrical damage. 2.Inductance shall not change more than ±20%.
9.Resistance To Soldering Heat Test	MIL-STD-202 Method 210 & J-STD020D.1	1.Highest temperature : 245±5℃ 2.Time ( temp. ≥ 217℃ ) : 60~150 Seconds. 3.IR reflow times : 3 times.	1.No mechanical or electrical damage. 2.Inductance shall not change more than ±20%.
10.Saturation Current	JIS C 6436 & User SPEC.	1.Applied rated current for 5 seconds. 2.Saturation current	Inductance shall not drop more than 35% typ.
11.Over load	JIS C 6436 & User SPEC.	1.Applied one and half rated current for a period of 5 minutes. 2.Rated current	No electrical or mechanical damage
12.Temperature Rise Current	JIS C 6436 & User SPEC.	1.Applied rated current for 10 minutes. 2.Temperature measure by digital surface thermometer. 3.Irms current	Surface temperature rise is less than 40℃ max.
13.Solderability Test	J-STD-002 & JESD22-B 102	1.Baking in pre-testing : 150±5℃ / 16Hours±30 min. 2.Peak temperature : 240±5℃ 3.Time ( temp. ≥ 217℃ ) : 60~150 seconds. 4.IR reflow times : 1 time.	More than 95% soldering coverage min on terminations.
14.Electrical Characteriazation	MIL-STD-202 Method 304 & User SPEC.	1.Operating temperature : -40℃~125℃ 2.Room temperature : 25℃.	1.No mechanical or electrical damage. 2.Inductance shall not change more than ±20%.
15.Drop	CNS-C6354 & GB/T 2423.8	1.Products shall be mounted on SPEC. PCB and dropped down from a height of 1m 2.Drop total time : 6 times (Every side of sample drop 2 times)	1. Adhesion on PCB shall be enough. 2. Product appearance shall not break. 3. No electrical damage.
16.Terminal Strength Test	IEC 60068-2-21	1.Apply push force to samples mounted on PCB. 2.Force of 1.8 kg for 60±1 seconds.	After test, inductors shall be no mechanical damage.

AR-001C