

SPECIFICATION FOR APPROVAL

REF. :

PROD. NAME	Shielded SMD Power Inductor	ABC'S DWG NO.		SU1048□□□□F□-□□□			
		REV.	20200916-H	PAGE	1		

I . Configuration and dimensions :

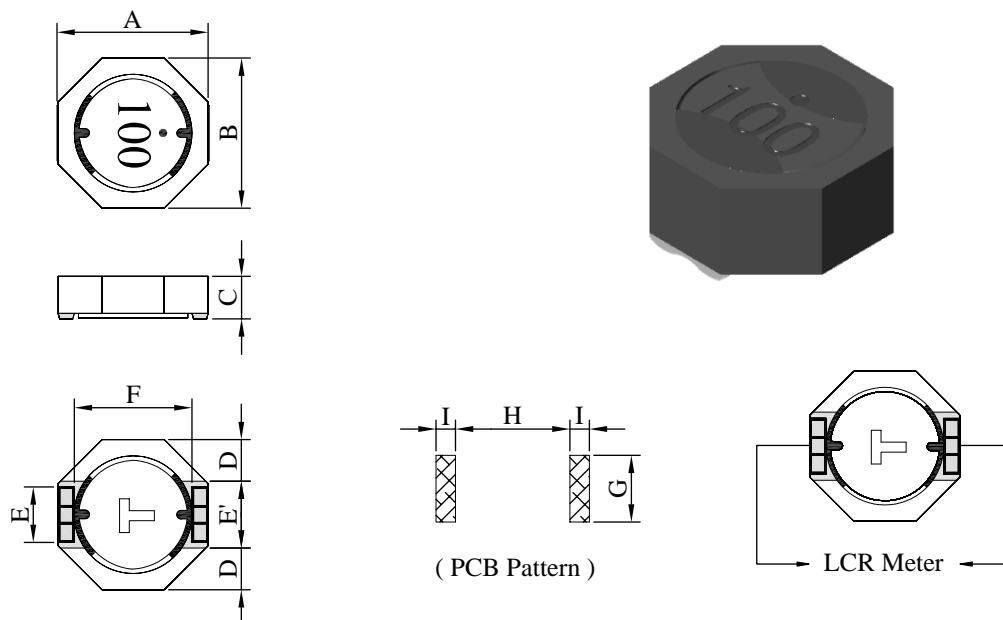

Unit : mm

A	B	C	D	E	E'	F	G	H	I
10.00 ±0.3	10.00 ±0.3	4.80 ±0.3	2.50 typ.	3.20 typ.	5.00 ±0.5	7.40 typ.	4.00 ref.	7.20 ref.	1.80 ref.

II . Description :

- a . Ferrite drum core construction
- b . Magnetically shielded
- c . Enamelled copper wire : F class
- d . Product weight : 1.63 g (ref.)
- e . Moisture sensitivity Level 1
- f . Products comply with RoHS' requirements
- g . Halogen free

III . General specification :

- a . Storage temp. : -40°C ----+125°C
- b . Operating temp. : -40°C ----+125°C
(Temp. rise included.)
- c . Resistance to solder heat : 260°C.10 sec.

Peak temp. : 245°C max.
 Max. peak temp. - 5°C : 30sec. max.
 Max. time above 217°C : 60sec.~150sec. max.

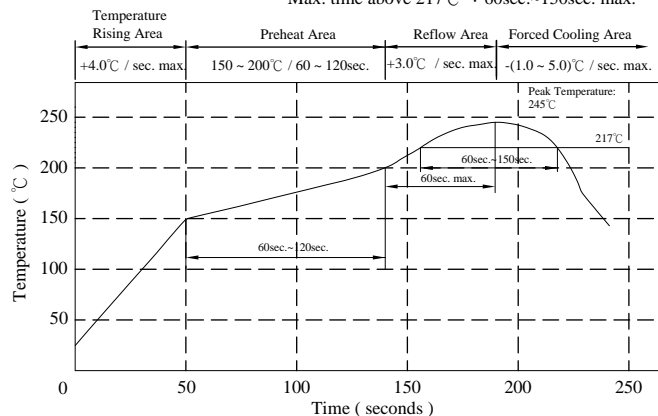

AR-001C

SPECIFICATION FOR APPROVAL

REF. :

PROD. NAME	Shielded SMD Power Inductor	ABC'S DWG NO.	SU1048□□□□F□-□□□		
		REV.	20200916-H	PAGE	2

IV . Electrical characteristics :

DWG. No.	Inductance (μ H)	Q ref.	SRF (MHz) typ.	RDC (m Ω)		Irms (A) max.	Isat (A) typ.
				typ.	max.		
SU1048R80YF□-□□□	0.8 \pm 30%	8	100	3.6	4.8	7.80	8.50
SU10481R5YF□-□□□	1.5 \pm 30%	14	70	4.3	5.8	7.00	7.20
SU10482R2YF□-□□□	2.2 \pm 30%	14	55	5.3	7.2	6.50	6.30
SU10483R0YF□-□□□	3.0 \pm 30%	14	40	7.2	10.0	6.20	6.00
SU10484R7YF□-□□□	4.7 \pm 30%	12	30	9.5	12.5	5.50	4.75
SU10486R8YF□-□□□	6.8 \pm 30%	10	20	13.6	18.0	4.80	4.10
SU10488R2YF□-□□□	8.2 \pm 30%	8	18	15.0	20.0	4.60	3.80
SU1048100YF□-□□□	10.0 \pm 30%	26	16	18.5	25.0	4.50	3.70
SU1048150YF□-□□□	15.0 \pm 30%	30	14	29.0	40.0	3.20	2.70
SU1048220YF□-□□□	22.0 \pm 30%	22	12	42.0	55.0	2.60	2.00
SU1048330YF□-□□□	33.0 \pm 30%	24	10	63.0	84.0	2.10	1.70
SU1048470YF□-□□□	47.0 \pm 30%	26	8	94.0	120.0	1.70	1.50
SU1048560YF□-□□□	56.0 \pm 30%	26	7	110.0	145.0	1.60	1.40
SU1048680YF□-□□□	68.0 \pm 30%	24	6	127.0	170.0	1.40	1.25
SU1048820YF□-□□□	82.0 \pm 30%	24	5.5	149.0	200.0	1.30	1.10
SU1048101YF□-□□□	100.0 \pm 30%	26	5	160.0	220.0	1.20	1.00
SU1048151YF□-□□□	150.0 \pm 30%	24	4.5	235.0	305.0	1.00	0.80
SU1048221YF□-□□□	220.0 \pm 30%	20	4	350.0	455.0	0.80	0.70
SU1048331YF□-□□□	330.0 \pm 30%	18	3	490.0	640.0	0.65	0.52

- 1). Electrical specifications at 25°C
- 2). Inductance Test Freq. : 100kHz / 1V
- 3). Q Test Freq. : R80--25.2MHz , 1R5~8R2--7.96MHz , 100~820--2.52MHz , 101~331--0.796MHz
- 4). Isat base on Δ L / L0A=35% typ.
- 5). Irms base on Temp. rise 30°C max.

AR-001C



千如電子集團
ABC-ATEC ELECTRONICS GROUP

SPECIFICATION FOR APPROVAL

REF. :

PROD. NAME	Shielded SMD Power Inductor	ABC'S DWG NO.	SU1048□□□□F□-□□□		
		REV.	20200916-H	PAGE	3

V . Curve :

SU10482R2YF□

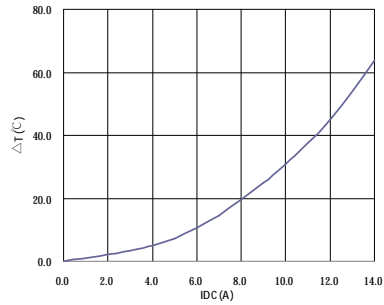
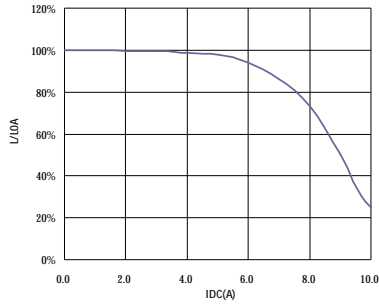

SU1048330YF□

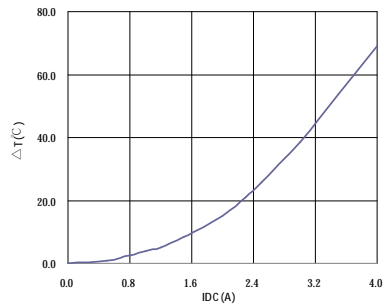
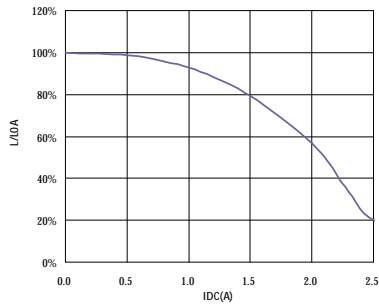

SU1048101YF□

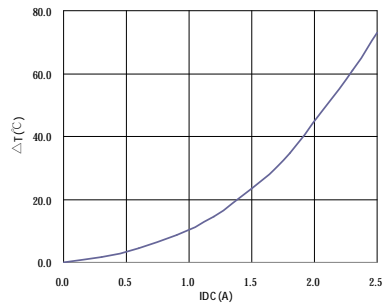
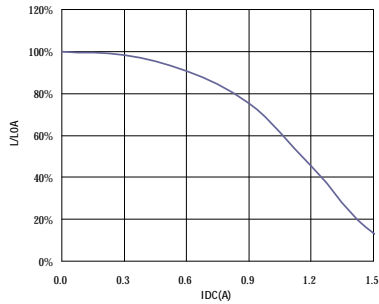

SU1048331YF□

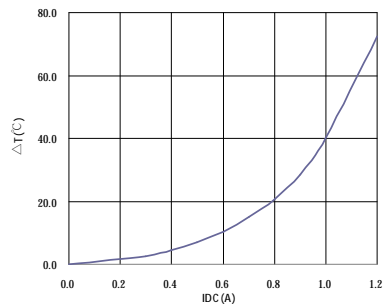
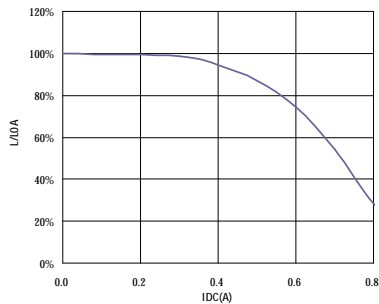

AR-001C

SPECIFICATION FOR APPROVAL

REF. :

PROD. NAME	Shielded SMD Power Inductor	ABC'S DWG NO.	SU1048□□□□F□-□□□		
		REV.	20200916-H	PAGE	4

VI . Packaging information :

(1) Configuration

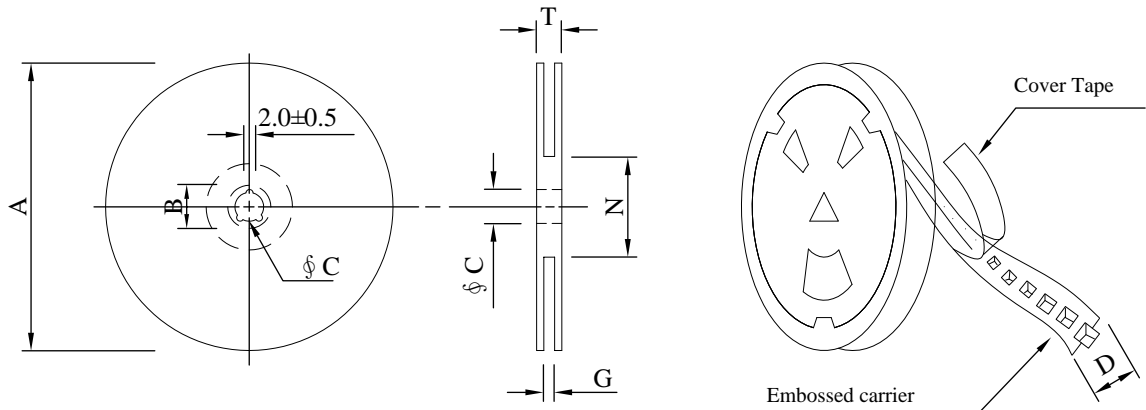

※Carrier tape width : D

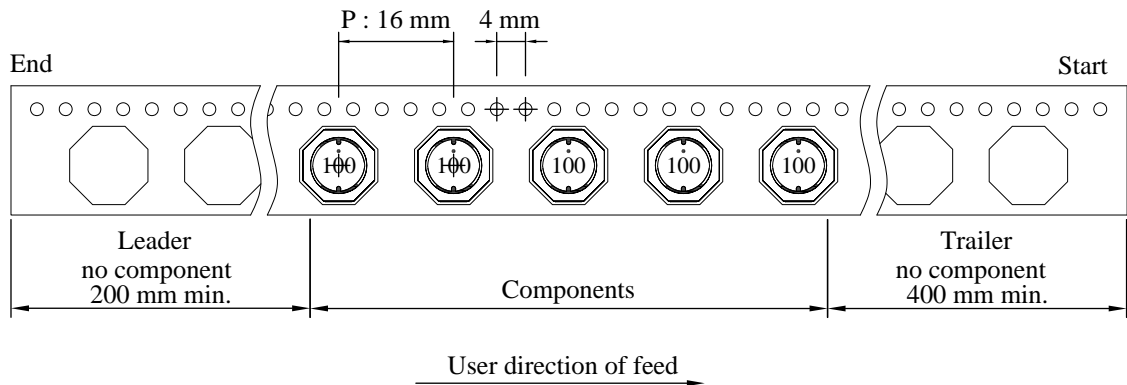

(2) Dimensions

Unit:mm

Style	A	B	C	D	G	N	T
13 - 24	330	21±0.8	13±0.5	24	26 ⁺⁰	60 ⁻⁰	30.4

(3) Q'TY & G.W. Per package

Code	Inner : Reel			Outer : Carton		
	Q'TY (pcs)	G.W. (g)	Style	Q'TY (pcs)	G.W. (kg)	Size (cm)
B	600	1330	13 - 24	2,400	6.6	38 x 37 x 22

AR-001C

SPECIFICATION FOR APPROVAL

REF. :

PROD. NAME	Shielded SMD Power Inductor	ABC'S DWG NO.		SU1048□□□□F□-□□□		
		REV.	20200916-H	PAGE	5	

VII . Drawing number expression :

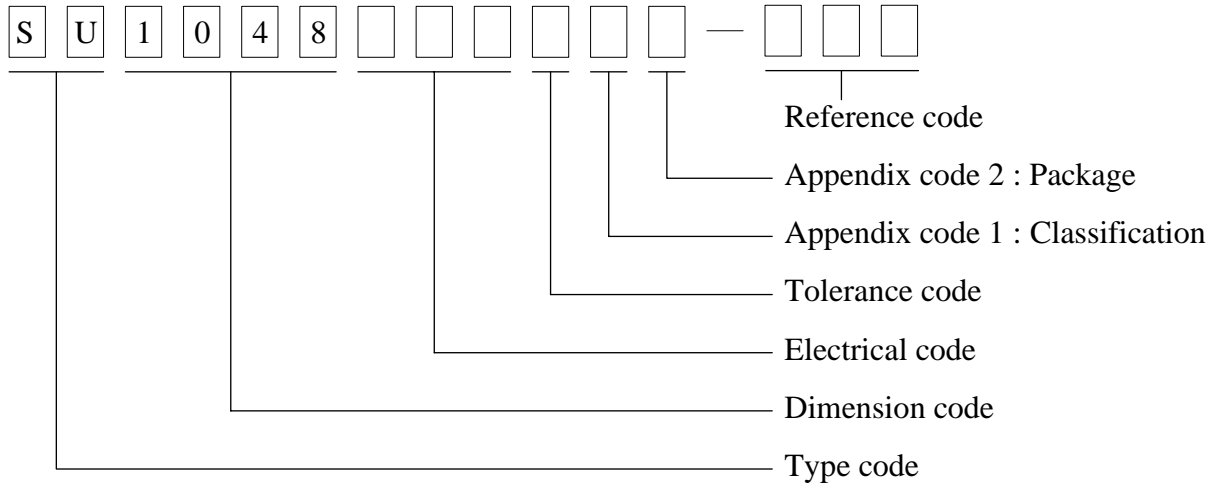

Appendix code 1 : Product Classification

Appendix code 2 : Package Information

Code	Inner package	Cover tape	Carrier tape	Bag	Package Q'TY	Remark
B	T /R (Reel package)	UCT	Antistatic	Antistatic	600 pcs	

SPECIFICATION FOR APPROVAL

REF. :

PROD. NAME	Shielded SMD Power Inductor	ABC'S DWG NO.	SU1048□□□□F□-□□□		
		REV.	20200916-H	PAGE	6

VIII . Reliability test :

Item	Reference documents	Test Condition	Test Specification
1.High Temperature Exposure	MIL-STD-202 Method 108	1.Temperature: 125±2°C 2.Time:96±2 hours.	1.No mechanical or electrical damage. 2.Inductance shall not change more than ±20%.
2.Temperature Cycling	JESD22-A 104	1.Temperature: -40°C ~ +125°C 2.Number of cycle:100 cycles 3.Dwell time:30 minutes	1.No mechanical or electrical damage. 2.Inductance shall not change more than ±20%.
3.Biased Humidity Test	MIL-STD-202 Method 103	1.Temperature : 85±2 °C 2.Humidity: 85% RH. 3.Time:96±2 Hours	1.No mechanical or electrical damage. 2.Inductance shall not change more than ±20%.
4.Operational Life	JESD22-A 108	1.Temperature: 125°C (Temp. rise included) 2.Time:96±2 hours. 3.Rated current	1.No mechanical or electrical damage. 2.Inductance shall not change more than ±20%.
5.External Visual	JESD22-B 101 & MIL-STD-883 Method 2009	Inspect product constructions, marking and workmanship.	1.No pollution on the surface of products. 2.Clear marking. 3.No crack.
6.Physical Dimensions	JESD22-B 100	Verify physical dimensions to the applicable product detail specification.	Per product specification standard
7.Resistance to solvents	MIL-STD-202 Method 215	Immerse into solvent for 3±0.5 minutes & brush 10 times for 3 cycles.	1.No body change in appearance. 2.No marking blurred. 3.Inductance shall not change more than ±20%.
8.Vibration Test	MIL-STD-202 Method 204	1.Frequency and Amplitued : 10-2000-10 Hz, 1.5 mm. 2.Direction:X, Y, Z 3.Test duration:2 hours for each direction, 6 hours in total.	1.No mechanical or electrical damage. 2.Inductance shall not change more than ±20%.
9.Resistance To Soldering Heat Test	MIL-STD-202 Method 210 & J-STD020D.1	1.Highest temperature : 245±5°C 2.Time (temp. ≥ 217°C) : 60~150 Seconds. 3.IR reflow times : 3 times.	1.No mechanical or electrical damage. 2.Inductance shall not change more than ±20%.
10.Saturation Current	JIS C 6436 & User SPEC.	1.Applied rated current for 5 seconds. 2.Saturation current	Inductance shall not drop more than 30% typ.
11.Over load	JIS C 6436 & User SPEC.	1.Applied one and half rated current for a period of 5 minutes. 2.Rated current	No electrical or mechanical damage
12.Temperature Rise Current	JIS C 6436 & User SPEC.	1.Applied rated current for 10 minutes. 2.Temperature measure by digital surface thermometer. 3.Irms current	Surface temperature rise is less than 30°C max.
13.Solderability Test	J-STD-002 & JESD22-B 102	1.Baking in pre-testing : 150±5°C / 16Hours±30 min. 2.Peak temperature : 240±5°C 3.Time (temp. ≥ 217°C) : 60~150 seconds. 4.IR reflow times : 1 time.	More than 95% soldering coverage min on terminations.
14.Electrical Characteriazation	MIL-STD-202 Method 304 & User SPEC.	1.Operating temperature : -40°C~125°C 2.Room temperature : 25°C .	1.No mechanical or electrical damage. 2.Inductance shall not change more than ±20%.
15.Drop	CNS-C6354 & GB/T 2423.8	1.Products shall be mounted on SPEC. PCB and dropped down from a height of 1m 2.Drop total time : 6 times (Every side of sample drop 2 times)	1. Adhesion on PCB shall be enough. 2. Product appearance shall not break. 3. No electrical damage.
16.Terminal Strength Test	IEC 60068-2-21	1.Apply push force to samples mounted on PCB. 2.Force of 1.8 kg for 60±1 seconds.	After test, inductors shall be no mechanical damage.

AR-001C